



---

# OWNER'S OPERATING MANUAL

---



**VX-2ix**



**Digital Light Processing™ Projector  
and DHD Controller**



**THE WORLD'S FINEST HOME THEATER PRODUCTS™**



---

# TWO YEAR LIMITED WARRANTY

## For Projectors, Video Processors and Controllers

Congratulations on your purchase of a Runco video product and welcome to the Runco family! We believe Runco produces "The World's Finest Home Theater Products." With proper installation, setup and care, you should enjoy many years of unparalleled video performance.

This is a LIMITED WARRANTY as defined in the Magnuson-Moss Warranty Act. Please read it carefully and retain it with your other important documents.

### **WHAT IS COVERED UNDER THE TERMS OF THIS LIMITED WARRANTY:**

**SERVICE LABOR:** Runco will pay for service labor by a Runco Authorized Service Center when needed as a result of manufacturing defect for a period of two (2) years from the effective date of delivery to the end user (excluding the lamp).

**PARTS** (not including the lamp): Runco will provide new or rebuilt replacement parts for the parts that fail due to defects in materials or workmanship for a period of two (2) years from the effective date of delivery to the end user. Such replacement parts are then subsequently warranted for the remaining portion (if any) of the original warranty period.

**PROJECTOR LAMP:** Runco will pay for service labor by a Runco Authorized Service Center when needed as a result of a manufacturing defect for a period of six (6) months or 1000 hours, whichever comes first, from the effective date of delivery to the end user. In addition, Runco will provide a new or rebuilt replacement lamp for the lamp that fails due to defects in materials or workmanship for a period of six (6) months or 1000 hours, whichever comes first, from the effective date of delivery to the end user. Such replacement lamps are then subsequently warranted for the remaining portion (if any) of the original warranty period.

### **WHAT IS NOT COVERED UNDER THE TERMS OF THIS LIMITED WARRANTY:**

This Limited Warranty only covers failure due to defects in materials and workmanship that occur during normal use and does not cover normal maintenance. This Limited Warranty does not cover cabinets or any appearance items; failure resulting from accident, misuse, abuse, neglect, mishandling, misapplication, faulty or improper installation or setup adjustments; improper maintenance, alteration, improper use of any input signal; damage due to lightning or power line surges, spikes and brownouts; damage that occurs during shipping or transit; or damage that is attributed to acts of God. In the case of remote control units, damage resulting from leaking, old, damaged or improper batteries is also excluded from coverage under this Limited Warranty.

**CAUTION:** THIS LIMITED WARRANTY ONLY COVERS RUNCO PRODUCTS PURCHASED FROM RUNCO AUTHORIZED DEALERS. ALL OTHER PRODUCTS ARE SPECIFICALLY EXCLUDED FROM COVERAGE UNDER THIS WARRANTY. MOREOVER, DAMAGE RESULTING DIRECTLY OR INDIRECTLY FROM IMPROPER INSTALLATION OR SETUP IS SPECIFICALLY EXCLUDED FROM COVERAGE UNDER THIS LIMITED WARRANTY. IT IS IMPERATIVE THAT INSTALLATION AND SETUP WORK BE PERFORMED ONLY BY AN AUTHORIZED RUNCO DEALER TO PROTECT YOUR RIGHTS UNDER THIS WARRANTY. THIS WILL ALSO ENSURE THAT YOU ENJOY THE FINE PERFORMANCE OF WHICH YOUR RUNCO PRODUCT IS CAPABLE WHEN INSTALLED AND CALIBRATED BY RUNCO AUTHORIZED PERSONNEL.

### **RIGHTS, LIMITS AND EXCLUSIONS:**

Runco limits its obligations under any implied warranties under state laws to a period not to exceed the warranty period. There are no express warranties. Runco also excludes any obligation on its part for incidental or consequential damages related to the failure of this product to function properly. Some states do not allow limitations on how long an implied warranty lasts, and some states do not allow the exclusion or limitation of incidental or consequential damages. So the above limitations or exclusions may not apply to you. This warranty gives you specific legal rights, and you may also have other rights that vary from state to state.

---

**EFFECTIVE WARRANTY DATE:**

This warranty begins on the effective date of delivery to the end user. For your convenience, keep the original bill of sale as evidence of the purchase date.

**IMPORTANT - WARRANTY REGISTRATION:**

Please fill out and mail your warranty registration card. It is imperative that Runco knows how to reach you promptly if we should discover a safety problem or product update for which you must be notified.

**CONTACT A RUNCO AUTHORIZED SERVICE CENTER TO OBTAIN SERVICE:**

Repairs made under the terms of this Limited Warranty covering your Runco video product will be performed at the location of the product, during usual working hours, providing location of product is within normal operating distance from a Runco Authorized Service Center. In some instances it may be necessary for the product to be returned to the Runco factory for repairs. If, solely in Runco's judgment, location of product to be repaired is beyond normal operating distance of the closest Runco Authorized Service Center, or the repair requires the unit be returned to the Runco factory, it is the owner's responsibility to arrange for shipment of the product for repair. These arrangements must be made through the selling Runco Dealer. If this is not possible, contact Runco directly for a Return Authorization number and shipping instructions. Runco will return product transportation prepaid in the United States, unless no product defect is discovered. In that instance, shipping costs will be the responsibility of the owner.

**COPYRIGHT AND TRADEMARKS:**

© Copyright 2006 Runco International. This document contains proprietary information protected by copyright, trademark and other intellectual property laws. All rights are reserved. No part of this manual may be reproduced by any mechanical, electronic or other means, in any form, without prior written permission of the manufacturer.

Reflection, Enhanced GEN3, DHD, Vivix, Virtual Cinema, CineWide, AutoScope, O-Path, CinOptx, LiveLink, CSMS, SuperOnyx and VirtualWide are trademarks of Runco International.

THX and the THX logo are trademarks of THX Ltd. which may be registered in some jurisdictions. All rights reserved.

All other trademarks and registered trademarks used in this document are the property of their respective owners.

Runco International products are manufactured under one or more of the following patents: US. Patent 6755540 and Other Patents Pending.

---

**ADDITIONAL INFORMATION:**

To locate the name and address of the nearest Runco Authorized Service Center, or for additional information about this Limited Warranty, please call or write:

**RUNCO INTERNATIONAL, INC.**  
**Attn: Customer Service Department**  
**2900 Faber Street**  
**Union City, CA 94587**  
**Ph: (510) 324-7777**  
**Fax: (510) 324-9300**  
**Toll Free: (800) 23-RUNCO**

---

**RUNCO VIDEO-PRODUCT INFORMATION**  
**RETAIN THIS INFORMATION FOR YOUR RECORDS**

---

Model Purchased

---

Date

---

Serial Number

---

Runco Authorized Dealer Name

---

Address

---

City

---

State/Province

---

Postal Code

---

Phone

---

Fax

# Safety Precautions

Thank you for your purchase of this quality Runco video projector! It has been designed to provide you with the quality of video that is expected in a home theater. For the best performance, please read this manual carefully as it is your guide through the menus and operation.

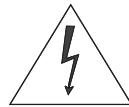
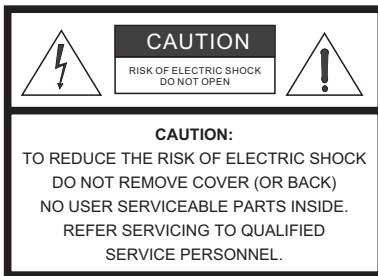

## WARNING

This symbol is intended to alert the user to the presence of uninsulated “dangerous voltage” within the product’s enclosure that may be of sufficient magnitude to constitute a risk of electric shock.



This symbol is intended to alert the user to the presence of important operating and maintenance (servicing) instructions in the literature accompanying the appliance.

This equipment has been tested and found to comply with the limits for a Class B digital device, pursuant to Part 15 of the FCC Rules. These limits are designed to provide reasonable protection against harmful interference in a residential installation.

1. Read these instructions.
2. Keep these instructions.
3. Heed all warnings.
4. Do not use this equipment near water, outdoors or otherwise exposed to the elements.
5. Clean only with a dry cloth.
6. Do not block any ventilation openings.
7. Do not install near any heat sources such as radiators, heat registers, stoves, or other apparatus (including amplifiers) that produce heat.
8. Do not defeat the safety feature of the polarized or grounding type plug. A polarized type plug has two blades with one wider than the other. A grounding type plug has two blades and a third grounding prong. The third prong is provided for your safety. If the provided plug does not fit into your outlet, consult an electrician for the replacement of the obsolete outlet.
9. The 12V trigger only outputs DC 12V signal for triggering. Do not connect to any other power input or output. This could cause damage to this unit.
10. Only use accessories specified by Runco International.
11. Keep the packing material in case the equipment should ever need to be shipped.
12. Unplug this projector during lightning storms or when it will not be used for an extended period of time.
13. The lamp becomes extremely hot during operation. Allow the projector to cool down for approximately 45 minutes prior to removing the lamp assembly for replacement. Do not operate lamps beyond the rated lamp life. Excessive operation of lamps beyond rated life could cause them to explode in rare occasions.
14. Refer all servicing to qualified service personnel. Servicing is required when the projector has been damaged in any way, objects have fallen or spilled into the projector, the projector has been exposed to rain or moisture, does not operate normally, or has been dropped.

# Table of Contents

---

<b>TWO YEAR LIMITED WARRANTY .....</b>	<b>iii</b>
<b>Safety Precautions .....</b>	<b>vi</b>
<b>1. Introduction .....</b>	<b>1</b>
About This Manual .....	1
Target Audience .....	1
If You Have Comments About This Manual.....	1
Textual and Graphic Conventions .....	1
Using This Manual .....	2
Description, Features and Benefits .....	3
Key Features and Benefits .....	4
Parts List .....	4
<b>2. Controls and Functions .....</b>	<b>5</b>
VX-2ix at a Glance .....	5
VX-2ix Rear Panel .....	6
VX-2ix Remote Control .....	9
<b>3. Installation .....</b>	<b>13</b>
Remote Control .....	13
Notes on Batteries .....	13
Notes on Remote Control Operation.....	13
Quick Setup .....	14
Installation Considerations .....	15
Installation Type.....	15
Ambient Light .....	15
Throw Distance.....	16
Vertical and Horizontal Position.....	17
Vertical and Horizontal Lens Shift.....	17
Folded Optics .....	19
Other Considerations.....	19
Installing the Optional CineWide Lens .....	19

---

Mounting the VX-2ix .....	20
Floor Mounting (Upright) .....	20
Ceiling Mounting (Inverted).....	20
Adjusting the Projection Angle .....	20
Connections to the VX-2ix .....	21
Connector Panel Access.....	21
Connecting the VX-2ix to Source Components.....	21
RS-232 Controller Connection .....	25
Connecting 12-Volt Trigger Outputs to External Theater Equipment.....	25
Connecting to AC Power .....	26
<b>4. Operation .....</b>	<b>27</b>
Turning on the Power .....	27
Adjusting the Picture Orientation .....	27
Lens Adjustments .....	28
Focus .....	28
Zoom .....	28
Shift .....	28
Using the On-Screen Menus .....	28
Main Menu .....	30
Input Source.....	30
Aspect Ratio.....	30
Picture .....	33
Input Position.....	36
ISF Presets .....	37
Information .....	37
Calibration .....	38
Service .....	40
<b>5. Maintenance and Troubleshooting .....</b>	<b>45</b>
Lamp Replacement .....	45
Lens Replacement .....	45
Troubleshooting Tips .....	49
<b>6. Serial Communications .....</b>	<b>51</b>
RS-232 Connection and Port Configuration .....	51
Serial Command Syntax .....	51
<b>7. Specifications .....</b>	<b>57</b>
VX-2ix Specifications .....	57
VX-2ix Dimensions .....	60



---

<b>APPENDIX A. VX-2ix Color Gamut Adjustment .....</b>	<b>A-1</b>
Required Hardware and Software .....	A-2
Serial Connections and Equipment Setup .....	A-2
Serial Command Syntax .....	A-3
Adjusting the Gamut .....	A-4

**Notes:**

# List of Figures

---

2-1. VX-2ix Front/Bottom/Side View .....	5
2-2. VX-2ix Rear Panel.....	6
2-3. VX-2ix Remote Control.....	9
3-1. Estimating Throw Distance .....	16
3-2. Projector Placement .....	17
3-3. Vertical Lens Shift (Example Only).....	18
3-4. Horizontal Lens Shift (Example Only).....	18
3-5. Folded Optics.....	19
3-6. DVI Source Connections .....	21
3-7. Digital (DTV) RGB Connections.....	22
3-8. Analog RGB Connections.....	23
3-9. Composite, S-Video and Component Video Connections.....	24
3-10. RS-232 Control System Connection.....	25
3-11. Connecting the 12-Volt Trigger Output to the AutoScope Lens Motor .....	25
3-12. Connecting a 12-Volt Trigger Output to Other Equipment.....	26
4-1. VX-2ix OSD Menu Structure .....	29
4-2. Typical PLUGE Pattern for Adjusting Brightness .....	33
4-3. Typical Gray Bar Pattern for Adjusting Contrast .....	34
4-4. Typical Color Bar Pattern for Adjusting Color Saturation and Tint.....	35
4-5. Typical Test Pattern for Adjusting Sharpness .....	36
7-1. VX-2ix Dimensions .....	60
A-1. CIE 1931 Chromaticity Diagram .....	A-1
A-2. Equipment Setup for Color Gamut Adjustment.....	A-2
A-3. VX-2ix Secondary RS-232 Port .....	A-3

**Notes:**

# 1. Introduction

---

This Owner's Manual describes how to install, set up and operate the Runco VX-2ix DLP Projector. Throughout this manual, the Runco VX-2ix DLP Projector is referred to simply as the "VX-2ix."

Runco has prepared this manual to help home theater installers and end users get the most out of the VX-2ix.

Runco has made every effort to ensure that this manual is accurate as of the date it was printed. However, because of ongoing product improvements and customer feedback, it may require updating from time to time. You can always find the latest version of this and other Runco product manuals on-line, at [www.runco.com](http://www.runco.com).

Runco welcomes your comments about this manual. Send them to [techpub@runco.com](mailto:techpub@runco.com).

**Text Conventions:** The following conventions are used in this manual, in order to clarify the information and instructions provided:

- Remote and built-in keypad button identifiers are set in upper-case bold type; for example, "Press **EXIT** to return to the previous menu."
- Computer input (commands you type) and output (responses that appear on-screen) is shown in monospace (fixed-width) type; for example: "To change the aspect ratio to Letterbox, type `LETTERBOX <Enter>`."
- All keys with functional names are initial-capped, set in bold type and enclosed in angle brackets. These keys are the following: **<Enter>**, **<Spacebar>**, **<Control>**, **<Esc>** and **<Tab>**.
- **<Enter>** indicates that you may press either the RETURN or ENTER key on your keyboard if it has both keys.

In addition to these conventions, underlining, boldface and/or italics are occasionally used to highlight important information, as in this example:



*A carriage return **must** be used after each command or string.*

---

## 1.1 About This Manual

### ◀ Target Audience

### ◀ If You Have Comments About This Manual...

### ◀ Textual and Graphic Conventions

**Graphic Conventions:** These symbols appear in numerous places throughout the manual, to emphasize points that you must keep in mind to avoid problems with your equipment or injury:



**Tip**

*TIPS highlight time-saving short cuts and helpful guidelines for using certain features.*



**Note**

*NOTES emphasize text with unusual importance or special significance. They also provide supplemental information.*



**Caution**

*CAUTIONS alert users that a given action or omitted action can degrade performance or cause a malfunction.*



**WARNING**

*WARNINGS appear when a given action or omitted action can result in damage to the equipment, or possible non-fatal injury to the user.*



**DANGER!**

*DANGER appears when a given action can cause severe injury or death.*

---

## 1.2 Using This Manual

Use the following table to locate the specific information you need in this manual.

<b>If you need...</b>	<b>... Turn to page:</b>
Information about obtaining service	iv
General information about the VX-2ix DLP Projector	3
Installation instructions	13
First-time configuration instructions	27
Advanced configuration instructions	38
Troubleshooting tips	49
VX-2ix DLP Projector specifications	57

Runco steps into the future once again with the Video Xtreme™ VX-2ix Digital Light Processing (DLP™) Projector, one of the world's first THX® Certified, high-definition home theater projectors.

**Note**

*THX recommends the use of 720p source material for optimal performance with this product.*

The VX-2ix optical light engine utilizes three, 16:9 SuperOnyx™ Digital Micromirror Device™ (DMD™) chips featuring 1280 x 720, high-definition resolution and 12-degree mirror tilt for unsurpassed black level performance. Unlike previous, single-chip DLP implementations, no color wheel is used. This reduces mechanical complexity and compromises to color spectrum purity. The impressive brightness inherent in 3-chip systems is further bolstered by the improved contrast capabilities of the VX-2ix light engine design, offering the best of both worlds.

The VX-2ix is equipped with an embedded, all-digital signal processor/controller featuring advanced Vivix II™ video processing, superb scaling and aspect ratio control. The VX-2ix is enhanced further by significant horizontal and vertical lens shift capability for maximum installation flexibility.

The VX-2ix produces an impressive 2500 ANSI lumens of light output (CSMS™ light output of 52.1 ft-Lamberts). The VX-2ix's 16:9 native aspect ratio DMD array makes it ideal for widescreen viewing, while its 3-chip, 1280 x 720 native resolution produces crisp, crystal clear high-definition images with richly saturated colors, deep black levels and natural, highly refined detail.

This advanced design provides pure digital connections from input to light engine for absolutely stellar pictures. In addition, Runco's multiple aspect ratio control includes its unique VirtualWide™ mode for viewing standard video formats in widescreen without loss of image quality.

For uncompromising widescreen reproduction of movies originally filmed in the "scope" (2.35:1) format, the VX-2ix can be equipped with Runco's patent-pending CineWide™ technology, a combination of software, electronics and high-quality anamorphic optics. CineWide maintains constant vertical height on the screen just as in a movie theater. When a viewer transitions from 1.78:1 (16:9) program material to 2.35:1, the image simply gets wider while full height is maintained. Also available with the VX-2ix is CineWide with AutoScope™, an enhanced, remote-controlled motorized version of CineWide.

**Note**

*CineWide requires the use of a 2.35:1 or similar aspect ratio superwide format screen.*

Discrete IR and RS-232 control make custom installation seamless, while discrete source and aspect ratio selection accommodate any automation control system.

---

## 1.3 Description, Features and Benefits

- Key Features and Benefits** ➤ The VX-2ix offers these key features and benefits:
- Native Resolution: 1280 x 720 (16:9 Native Aspect Ratio)
  - Three-chip Digital Light Processing (DLP™) system
  - Two DVI Inputs with High-bandwidth Digital Content Protection (HDCP)
  - HDTV Compatible
  - CinOptx™ *Proteus* lens options for stunning sharpness and throw distance flexibility

- Parts List** ➤ Your VX-2ix is shipped with the following items. If any items are missing or damaged, please contact your Runco dealer or Runco Customer Service at (800) 23-RUNCO.
- VX-2ix DLP Projector
  - Remote Control Unit and two (2), AAA-size batteries
  - DVI Cable, 16.4 feet (5.0 meters)
  - AC Power Cord
  - 3.0-mm, Ball-Point Hex Driver
  - (1) Warranty information and registration card
  - Runco VX-2ix Owner's Operating Manual (this document)

**Optional Accessories:**

- CineWide™ technology (fixed, secondary anamorphic lens)
- CineWide™ with AutoScope™ system (secondary anamorphic lens and motorized mount)
- Ceiling mount kit
- LiveLink™ DVI Cabling System



## 2. Controls and Functions

Figure 2-1 shows the key VX-2ix components.

### 2.1 VX-2ix at a Glance

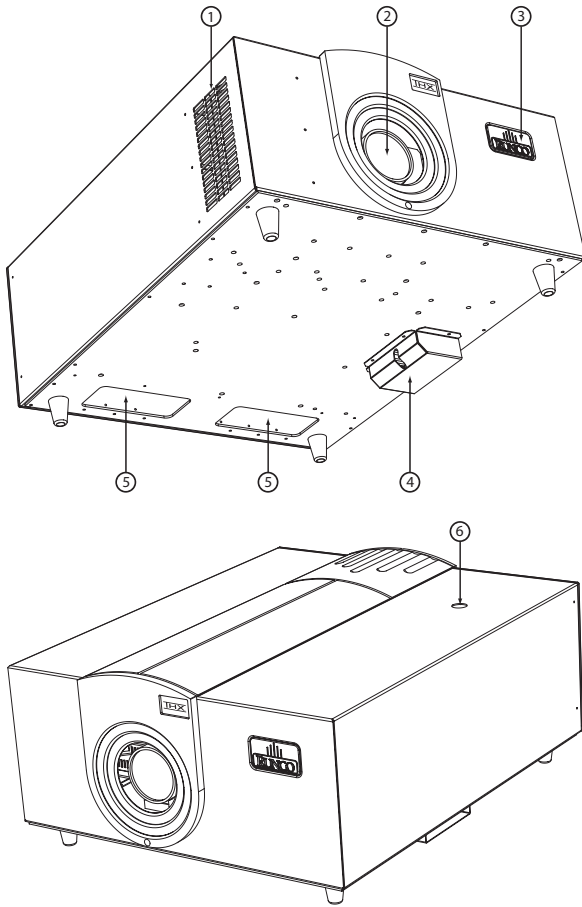

**Figure 2-1. VX-2ix Front/Bottom/Side View**

1. **INTAKE VENT**
2. **LENS**
3. **RUNCO LOGO**  
The logo can be rotated to match the projector orientation: inverted (ceiling-mounted) or upright. To rotate the logo, grip it at the sides, pull it away from the projector and rotate it 180 degrees.
4. **EXHAUST VENT**
5. **CABLE OPENINGS**  
Pass cables through these openings.
6. **IR SENSOR**

## 2.2 VX-2ix Rear Panel

Figure 2-2 shows the VX-2ix rear panel.

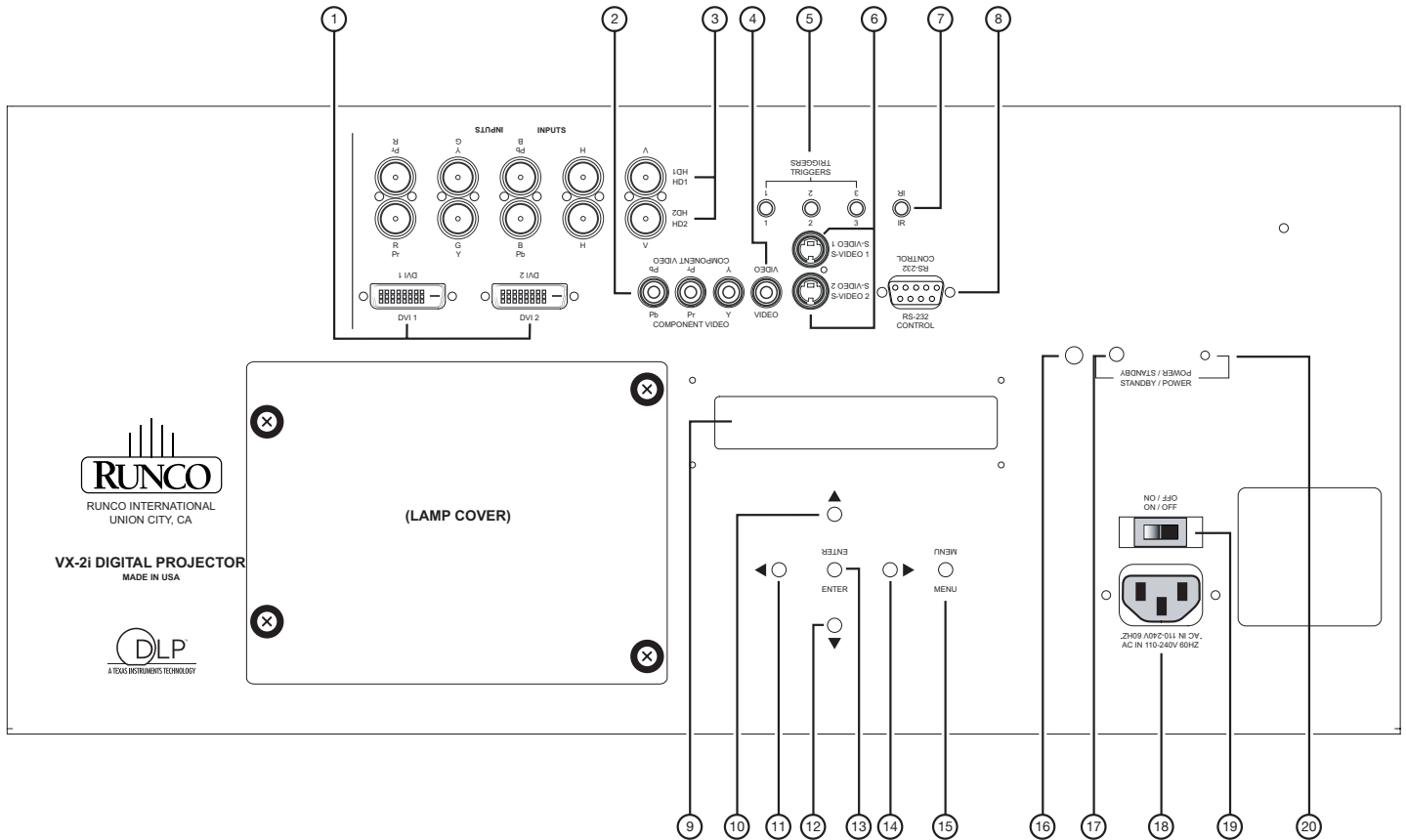

Figure 2-2. VX-2ix Rear Panel

1. **DVI 1 / DVI 2 (Digital)**  
Two, HDCP-compliant digital video inputs for connecting a DVD player or HD tuner with a DVI or HDMI output.
2. **COMPONENT VIDEO (RCA connectors)**  
Standard Definition (480i/576i) Component (YPrPb) input. This is the input for component video from sources such as DVD players.



Tip

*For best results, do not run your DVD player in progressive mode.*

3. **HD1 / HD2 (Analog BNC connectors)**  
Two inputs (five BNCs per input) for connecting either RGB or component high-definition television signals. The VX-2ix automatically detects the signal format: RGB(HV) or YPrPb, 480p, 720p, 480i, 576i or 1080i.
4. **COMPOSITE VIDEO INPUT**  
Standard composite video input for connecting a VCR, laser disc player or other composite video source.

#### 5. **12-VOLT (750 mA) TRIGGER OUTPUTS**

Connection for up to three (3), 12-volt trigger-controlled devices. These can be retractable screens, screen masks or the Runco CineWide with AutoScope system.

#### 6. **S-VIDEO 1 / S-VIDEO 2**

Two, standard S-Video inputs for connecting a DVD player, satellite receiver or Super VHS (S-VHS) VCR.

#### 7. **IR**

Wired input from an external remote control or infrared receiver. It is a 3.5-mm, mini phono jack, wired as follows:

Ring = +5V

Tip = IR Input

Sleeve = Ground



#### **Note**

*When an external remote control or infrared receiver is connected to the wired IR input, the IR sensors on the projector are disabled.*

#### 8. **RS-232 CONTROL PORT**

A female, 9-pin D-sub connector for interfacing with a PC or home theater automation/control system.

#### 9. **VACUUM FLUORESCENT DISPLAY**

Can be used instead of the On-Screen Display (OSD). Displays currently-selected menu or – if no menu is selected – the current source, signal format (NTSC or PAL), input resolution and aspect ratio.

#### 10. **UP BUTTON**

Use to direct-select aspect ratios or move the menu cursor up in the On-Screen Display. When no menus are present on-screen, the **UP** button toggles you through aspect ratios in the following order:

Anamorphic - Standard (4:3) - Letterbox - VirtualWide - Cinema - Virtualwide 2.35

(Virtualwide 2.35 is available only on CineWide-equipped projectors. For more information about aspect ratios, refer to Table 4-1.)

#### 11. **LEFT BUTTON**

Used to direct-select inputs or move the menu cursor left in the On Screen Display. When no menu is present on-screen, the **LEFT** button toggles you through the different sources, in this order:

DVI 2 - DVI 1 - HD/RGB2 - HD/RGB1 - Component SD - S-Video 2 - S-Video 1 - Composite

#### 12. **DOWN BUTTON**

Use to direct-select aspect ratios or move the menu cursor down in the On-Screen Display. When no menu is present on-screen, this button toggles you through the different aspect ratios, in this order:

Virtualwide 2.35 - Cinema - VirtualWide - Letterbox - Standard (4:3) - Anamorphic

#### 13. **ENTER BUTTON**

When an item is highlighted on the On-Screen Display, the **ENTER** button selects the item.

14. **RIGHT BUTTON**

Used to direct-select inputs or move the menu cursor right in the On Screen Display. When no menus are present on-screen, the **RIGHT** button toggles you through the different sources, in this order:

Composite - S-Video 1 - S-Video 2 - Component SD - HD/RGB 1 - HD/RGB 2 - DVI 1 - DVI 2

15. **MENU BUTTON**

Pressing the **MENU** button brings up the main menu. Also, if you are in an adjustment mode or function, pressing **MENU** brings the menu back one level.

16. **IR SENSOR**

Receives the IR commands from the remote.

17. **POWER BUTTON**

Press once to turn on the VX-2ix. Press it again to put it into Standby mode. For a discrete on or off command, you can use the direct access buttons on the remote control.

18. **POWER INPUT (100 to 240 VAC)**

Connect the VX-2ix to power here.

19. **MAIN POWER SWITCH**

Disconnects or applies power to the VX-2ix.

20. **POWER/STANDBY LED**

Figure 2-3 shows the VX-2ix remote control, and the paragraphs that follow describe its functionality.

## 2.3 VX-2ix Remote Control

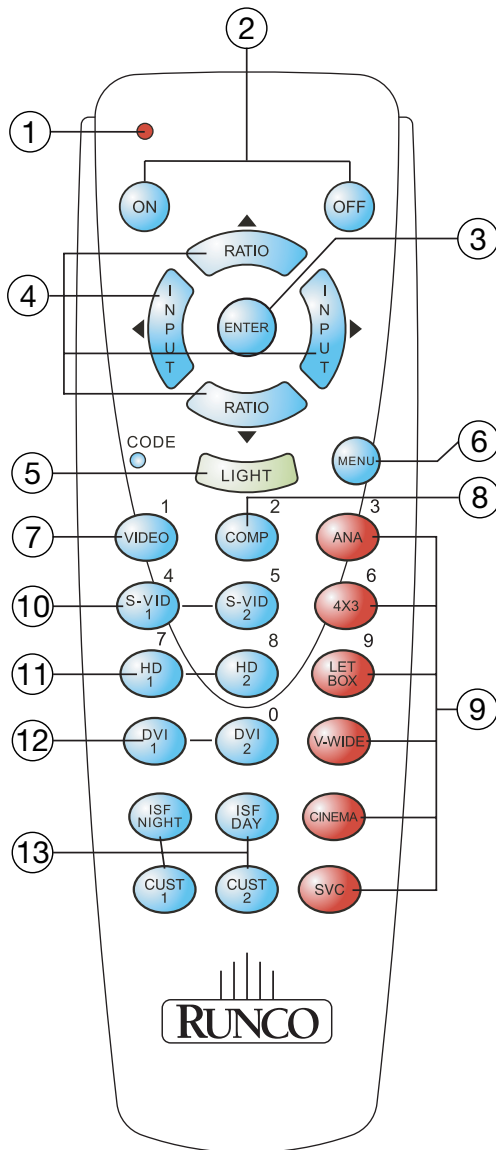

Figure 2-3. VX-2ix Remote Control

1. **IR OUTPUT INDICATOR**  
Lights when a button is pressed to indicate that an IR signal is being transmitted.
2. **ON / OFF**  
Press to turn the projector on or off.
3. **ENTER**  
Press to select a highlighted menu item or confirm a changed setting.
4. **Cursor Buttons (▲, ◀, ▼, ▶)**  
Use these buttons to select items or settings, adjust settings or switch display patterns.

When no menus are present on-screen, the **UP** and **DOWN** buttons toggle through the available aspect ratios, in this order:

**UP** Button = Anamorphic - Standard (4:3) - Letterbox - VirtualWide - Cinema - Virtualwide 2.35

**DOWN** Button = Virtualwide 2.35 - Cinema - VirtualWide - Letterbox - Standard (4:3) - Anamorphic



**Note**

*Virtualwide 2.35 is available only on CineWide-equipped projectors.  
For more information about aspect ratios, refer to Table 4-1.*

Likewise, the **LEFT** and **RIGHT** buttons toggle through the different source inputs, in this order:

**LEFT** Button = DVI 2 - DVI 1 - HD/RGB2 - HD/RGB 1 - Component SD - S-Video 2 - S-Video 1 - Composite

**RIGHT** Button = Composite - S-Video 1 - S-Video 2 - Component SD - HD/RGB 1 - HD/RGB 2 - DVI 1 - DVI 2

5. **LIGHT**  
Press to illuminate the buttons. (Not available on all models.)
6. **MENU**  
Press this button to access the OSD controls, or to exit the current menu and return to the previous one.
7. **VIDEO (1)**  
Press to select Composite video input as the source or to enter the numeric character "1."
8. **COMP (Component) (2)**  
Press to select Component SD (480i/576i) video input as the source or to enter the numeric character "2."

---

**9. Aspect Ratio Selection Buttons**

Use the red buttons to select an aspect ratio directly or to enter numeric characters, as follows:

**ANA (Anamorphic) (3)**

For viewing 16:9 DVDs or HDTV programs in their native aspect ratio.

**4X3 (Standard 4:3) (6)**

Scales the input signal to fit 4:3 display mode in the center of the screen.

**LETBOX (Letterbox) (9)**

For viewing LaserDisc movies or non-anamorphic DVDs on a 4:3 screen.

**V-WIDE (VirtualWide)**

Enlarges a 4:3 image horizontally in a NON-linear fashion to fit 16:9 full screen display.

**CINEMA**

For viewing 2.35:1 source material.

**SVC (CineWide-equipped projectors only)**

Selects the Virtualwide 2.35 aspect ratio, used for viewing 16:9 source material on a 2.35:1 screen.

**10. S-VID 1 (4) / S-VID 2 (5) (S-Video)**

Press to select an S-Video input or to enter the numeric character "4" or "5."

**11. HD 1 (7) / HD 2 (8)**

Press to select a HD (RGBHV or YPbPr component) input or to enter the numeric character "7" or "8."

**12. DVI 1 / DVI 2 (0)**

Press to select a Digital Video input. Press **DVI2** to enter the numeric character "0."

**13. Memory Preset Buttons:****ISF™ NT (Night)**

Press to recall settings for the current input from the "ISF Night" memory preset.

**ISF DAY**

Press to recall settings for the current input from the "ISF Day" memory preset.

**CUST 1**

Press to recall settings for the current input from the "Custom 1" memory preset.

**CUST 2**

Press to recall settings for the current input from the "Custom 2" memory preset.

**Notes:**



# 3. Installation

To install batteries in the remote control, press up on the battery cover retainer clip and lift off the cover. Install the two AAA batteries with the correct polarity and then replace the cover.

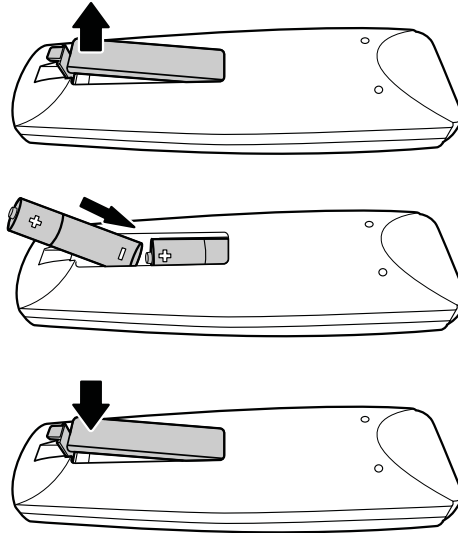

## 3.1 Remote Control

- Make sure that the battery polarities are correct when installing the batteries.
- Do not mix an old battery with a new one or different types of batteries.
- If you will not use the remote control for a long time, remove the batteries to avoid damage from battery leakage.
- Make sure that there is nothing obstructing the infrared beam between the remote control and the IR receiver on the projector.
- If the effective range of the remote control decreases, or it stops working, replace the batteries with new ones.
- The remote control may fail to operate if the infrared remote sensor is exposed to bright sunlight or fluorescent lighting.
- Ambient conditions may possibly impede the operation of the remote control. If this happens, point the remote control at the projector, and repeat the operation.
- The Ø icon appears on the screen when a button for an unavailable function is pressed.

### ◀ Notes on Batteries

### ◀ Notes on Remote Control Operation

## 3.2 Quick Setup

Table 3-1 gives a quick overview of the VX-2ix installation process. The sections following this one provide detailed instructions.



**Note**

*Installation should be performed by a qualified custom video installation specialist.*

**Table 3-1. Installation Overview**

Step	Procedure	For Details, Refer to page...
1	Choose a location for the projector	15
2	Install CineWide (secondary anamorphic) lens (optional)	19
3	Connect signal sources to the projector	21
4	Connect external controller to RS-232 port (optional)	25
5	Connect AutoScope lens motor or other home theater equipment to 12-volt trigger outputs (optional)	25
6	Apply power to the projector	26, 27
7	For rear-screen and/or ceiling-mount installations, select the proper picture orientation	27
8	Lens adjustments: projected image size (zoom), position (shift) and focus	17, 28
9	Projector calibration: adjust the following <b>for each input</b> , starting with Component SD; save settings when finished: <ul style="list-style-type: none"> <li>• Aspect ratio</li> <li>• Brightness</li> <li>• Contrast</li> <li>• Color level</li> <li>• Tint</li> <li>• Input position</li> </ul>	30 through 37

Proper installation of your projector will ensure the quality of your display. Whether you are installing a projector temporarily or permanently, you should take the following into account to ensure your projector performs optimally.

Choose the installation type that best suits your needs: front or rear screen, floor mount or inverted mount. Table 3-2 compares these various installation methods.

**Table 3-2. Projector Installation Options**

Advantages	Considerations
<b>Front Screen, Floor Mount Installation</b>	
<ul style="list-style-type: none"> <li>• Easy to set up</li> <li>• Can be moved or changed quickly</li> <li>• Easy to access</li> </ul>	<ul style="list-style-type: none"> <li>• Shares floor space with audience</li> </ul>
<b>Front Screen, Inverted Mount (ceiling) Installation</b>	
<ul style="list-style-type: none"> <li>• Does not take up audience space</li> <li>• Projector is unobtrusive</li> <li>• Projector cannot be accidentally moved</li> </ul>	<ul style="list-style-type: none"> <li>• Installation is more permanent</li> <li>• Projector access is more difficult</li> </ul>
<b>Rear Screen, Floor Mount Installation</b>	
<ul style="list-style-type: none"> <li>• Projector is completely hidden</li> <li>• Projector is easily accessed</li> <li>• Usually good ambient light rejection</li> </ul>	<ul style="list-style-type: none"> <li>• Requires separate room</li> <li>• Installation cost is usually higher</li> </ul>
<b>Rear Screen, Inverted Mount (ceiling) Installation</b>	
<ul style="list-style-type: none"> <li>• Projector is completely hidden</li> <li>• Usually good ambient light rejection</li> </ul>	<ul style="list-style-type: none"> <li>• Requires separate room</li> <li>• Installation cost is usually higher</li> </ul>
<b>Rear Screen, Floor Mount with Mirror</b>	
<ul style="list-style-type: none"> <li>• Projector is completely hidden</li> <li>• Usually good ambient light rejection</li> <li>• Requires less space behind screen than other rear screen installations</li> </ul>	<ul style="list-style-type: none"> <li>• Requires separate room</li> <li>• Installation cost is usually higher</li> </ul>

In general, minimize or eliminate light sources directed at the screen. Contrast ratio in your images will be noticeably reduced if light directly strikes the screen, such as when a shaft of light from a window or floodlight falls on the image. Images may then appear washed out and less vibrant.

### 3.3 Installation Considerations

#### ◀ Installation Type

#### ◀ Ambient Light

**Throw Distance** ➤ Throw distance is the distance measured from the front of the projector to the screen. This is an important calculation in any projector installation as it determines whether or not you have enough room to install your projector with a desired screen size and if your image will be the right size for your screen.

You can quickly estimate the throw distance by taking the width of the screen and multiplying it by the lens throw ratio; see Figure 3-1. The result of this calculation tells you roughly how far back the projector should be positioned from the screen in order to project a focused image large enough to fill the screen.

**Estimating Throw Distance**

Throw Distance (TD) = Screen Width (w) x Lens Throw Ratio

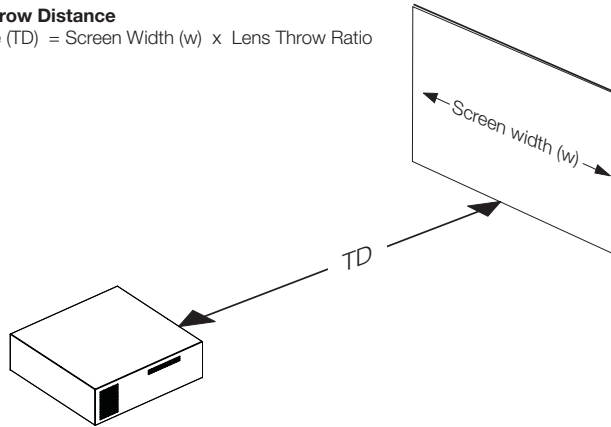

**Figure 3-1. Estimating Throw Distance**

Table 3-3 lists the available lens options for the VX-2ix and their associated throw ratios.

**Table 3-3. VX-2ix Lens Options and Throw Ratios**

Lens Option (Note 2)	Throw Ratio with Primary Lens Only	Throw Range in inches, with 96x54-inch (1.78:1) Screen		Throw Ratio with Primary Lens and Anamorphic Lens	Throw Range in inches, with 126.9x54-inch (2.35:1) Screen	
		Minimum	Maximum		Minimum	Maximum
Proteus A	0.64 (Fixed)	For rear-screen installations only. Contact Runco Technical Support for more information.		Not Applicable (Note 2)		
Proteus B	1.22 - 1.44	117.12	138.24			
Proteus C	1.45 - 1.76	139.20	168.96			
Proteus D	1.82 - 2.39	174.72	229.44	1.39 - 1.77	176.39	224.61
Proteus E	2.42 - 3.57	232.32	342.72	1.84 - 2.64	233.50	335.02
Proteus F	3.63 - 5.72	348.48	549.12	2.75 - 4.26	348.98	540.59

**Notes:**

1. Throw distance does not affect image quality, provided these ranges are taken into account.
2. Only the Proteus D, E and F lenses can be used with the optional CineWide (secondary anamorphic) lens. Doing so affects the throw distances as shown here.

Proper placement of the projector relative to the screen will yield a rectangular, perfectly-centered image that completely fills the screen.

Ideally, the projector should be positioned perpendicular to the screen and in such a way that the lens center and screen center are aligned with each other, as shown in Figure 3-2.

### ◀ Vertical and Horizontal Position

#### Ceiling Installation

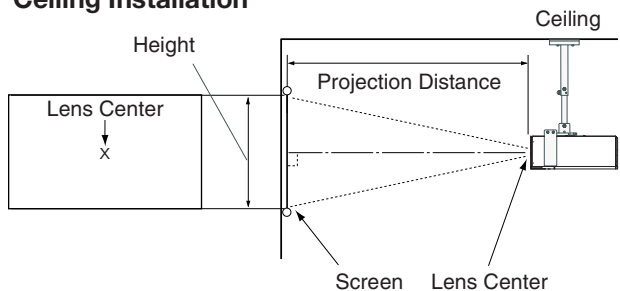

#### Floor Installation

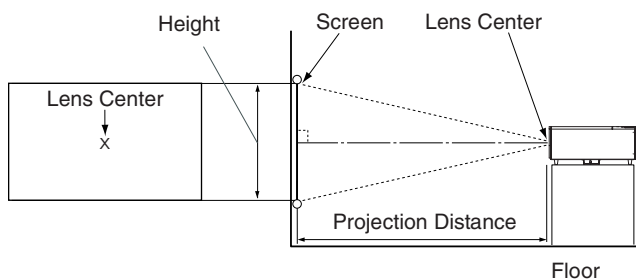

**Figure 3-2. Projector Placement**

If it is not possible to align the projector and screen as shown in Figure 3-2, you can use the lens shift controls to center the image on the screen. Lens shift is generally expressed as a percentage of the screen height or width, as shown in Figure 3-3 and Figure 3-4.

### ◀ Vertical and Horizontal Lens Shift

**Vertical Lens Shift:** The VX-2ix zoom lenses (Proteus B through F) provide up to 80% of downward vertical lens shift. For example, with a 96 x 54-inch (16:9) screen, you can shift the image up to 43.20 inches (1.10 meters) below the screen center. (Upward vertical lens shift is not possible. Vertical lens shift is not possible in either direction with the Proteus A lens.)

**Horizontal Lens Shift:** The VX-2ix zoom lenses (Proteus B through F) allow up to 10% of horizontal lens shift in either direction (left or right). For example, with a 96 x 54-inch (16:9) screen, you can shift the image up to 9.60 inches (24.38 cm) left or right of the screen center. (Horizontal lens shift is not possible with the Proteus A lens.)



#### Note

1. With no vertical or horizontal lens shift, the lens center and screen center are aligned with each other.
2. Vertical shift limits are percentages of the screen height. Horizontal shift limits are percentages of the screen width.
3. **Vertical lens shift figures apply to ceiling mount configurations.** For floor installations (where the projector is upright), reverse the up/down vertical offset percentages.

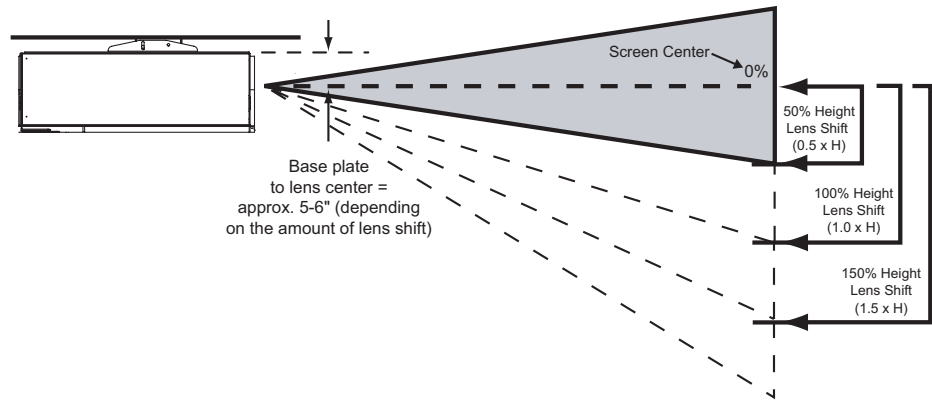

**Note:** This is a general example of lens shift. Lenses vary in their shift capabilities. **No particular lens or projector is used in this example.**

**Figure 3-3. Vertical Lens Shift (Example Only)**

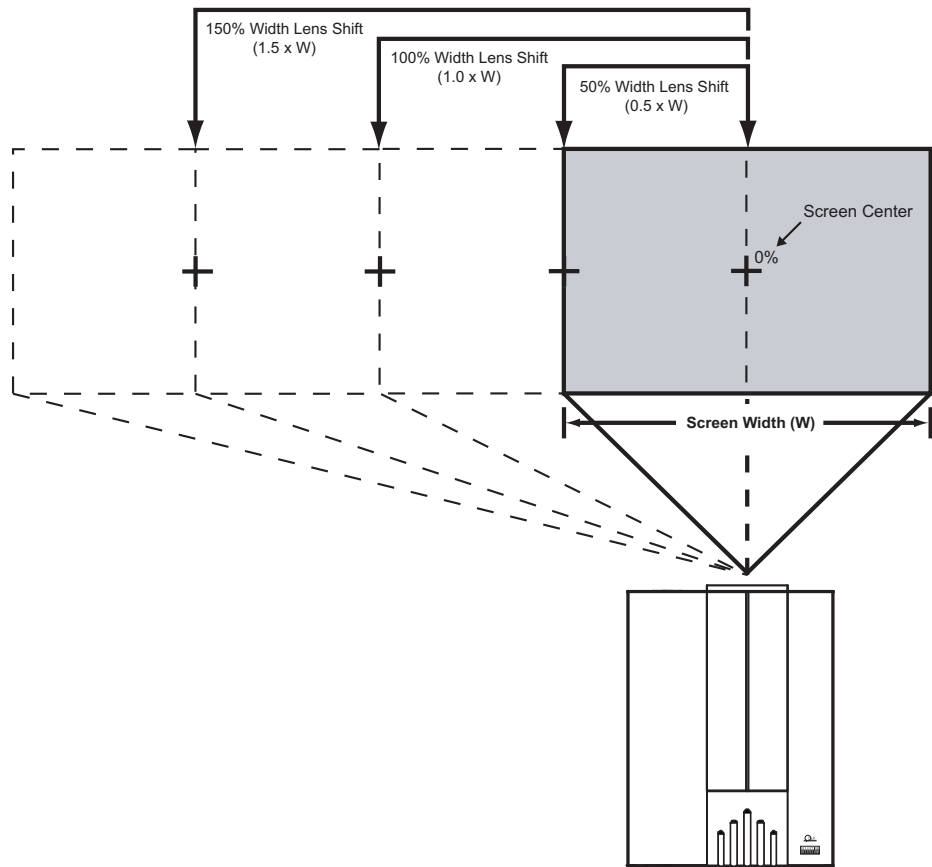

**Note:** This is a general example of lens shift. Lenses vary in their shift capabilities. **No particular lens or projector is used in this example.**

**Figure 3-4. Horizontal Lens Shift (Example Only)**

In rear screen applications where space behind the projector is limited, a mirror may be used to fold the optical path, as shown in Figure 3-5. The position of the projector and mirror must be accurately set. If you are considering this type of installation, contact your dealer for assistance.

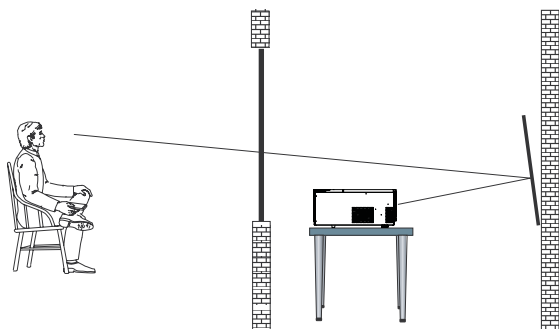

**Figure 3-5. Folded Optics**

Other considerations and tips that can help improve your installation:

- Keep the ambient temperature constant and below 35°C (95°F). Keep the projector away from heating and/or air conditioning vents. Changes in temperature may cause drifts in the projector circuitry, which may affect performance.
- Keep the projector away from devices that radiate electromagnetic energy such as motors and transformers. Common sources of these include slide projectors, speakers, power amplifiers and elevators.

If you are installing a VX-2ix with the optional CineWide or CineWide with AutoScope system, install the secondary anamorphic lens in accordance with the instructions provided with the lens installation kit.

### ◀ **Folded Optics**

### ◀ **Other Considerations**

---

## **3.4 Installing the Optional CineWide Lens**

### 3.5 Mounting the VX-2ix

There are several methods for mounting the projector. Depending on your chosen installation, one method may be more suitable than another.

#### **Floor Mounting (Upright)** ➤

In typical front and rear screen installations, the projector can be mounted to a secure and level surface such as a table or cart. Carts are useful when moving a projector during a presentation or from site to site. If possible, lock the wheels when it's in position to prevent it from being moved during a presentation.

#### **Ceiling Mounting (Inverted)** ➤

For fixed installations, and for those that want the projector out of sight or have a limited space for projector and audience, you can invert the VX-2ix and suspend it from the ceiling using a specially-designed ceiling mount fixture.



#### **Note**

*Use only the Runco-approved ceiling mount kit designed for your projector. Install the mount kit according to the instructions provided with it.*

The projector can also be inverted and placed in an enclosure above and behind the viewing area. Install four feet on the inside bottom surface of the enclosure on which the projector can rest. A variety of materials can be used for this purpose (for example, rubber crutch tips or turntable feet).

#### **Adjusting the Projection Angle** ➤

If the screen is significantly higher or lower than the projector, you can also tilt the projector at a slight angle. In a ceiling installation, you do this by adjusting the ceiling mount.

If you do this, you may need to shift the image using the on-screen display (OSD) controls, to compensate. For detailed instructions, refer to **Using the On-Screen Menus** on page 28.



Proceed as follows to connect the VX-2ix to your video sources, external controller(s) – if present – and AC power.

When connecting your equipment:

- Turn off all equipment before making any connections.
- Use the correct signal cables for each source.
- Ensure that the cables are securely connected. Tighten the thumbscrews on connectors that have them.

To access the connector panel, pull firmly on the cable access cover to open it.

Connect your video sources to the VX-2ix as shown and described in the sections that follow.

**DVI Connections:** See Figure 3-6.



**Tip**

*Use the DVI inputs whenever possible. This ensures the highest video quality because the signal is carried in the digital domain throughout the entire signal path, from source component output into the projector.*

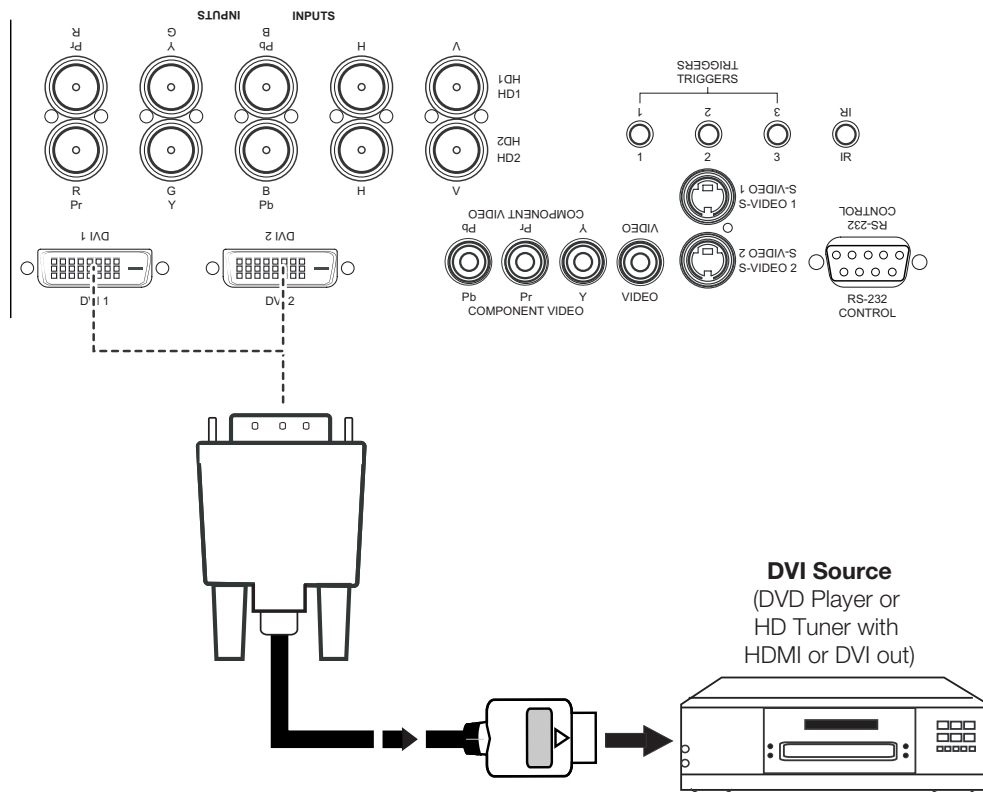

**Figure 3-6. DVI Source Connections**

### 3.6 Connections to the VX-2ix

#### ◀ Connector Panel Access

#### ◀ Connecting the VX-2ix to Source Components

**Digital (DTV) RGB or Component Video Connections:** See Figure 3-7.

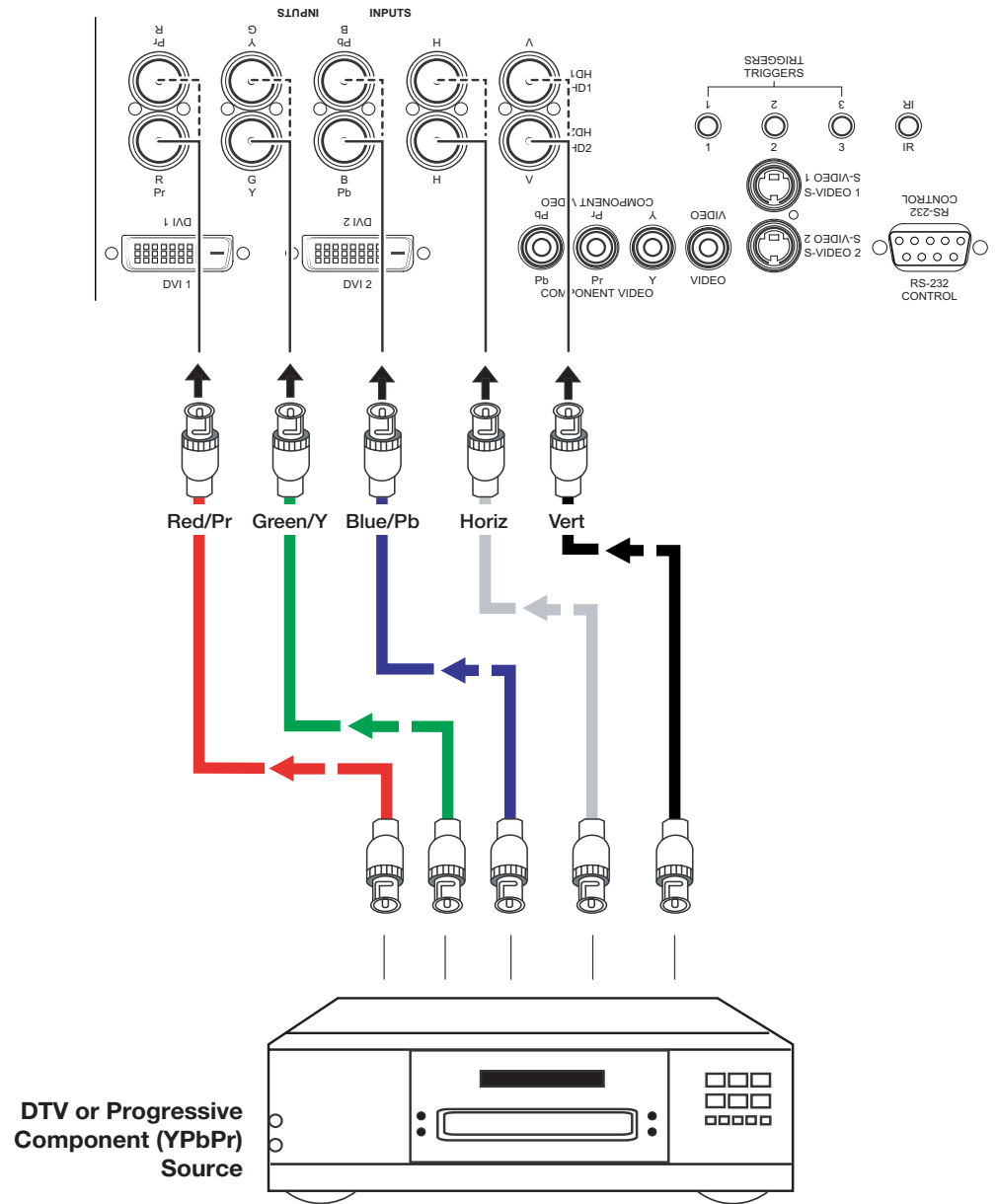

**Figure 3-7. Digital (DTV) RGB Connections**

**Analog (Computer) RGB Connections:** See Figure 3-8.

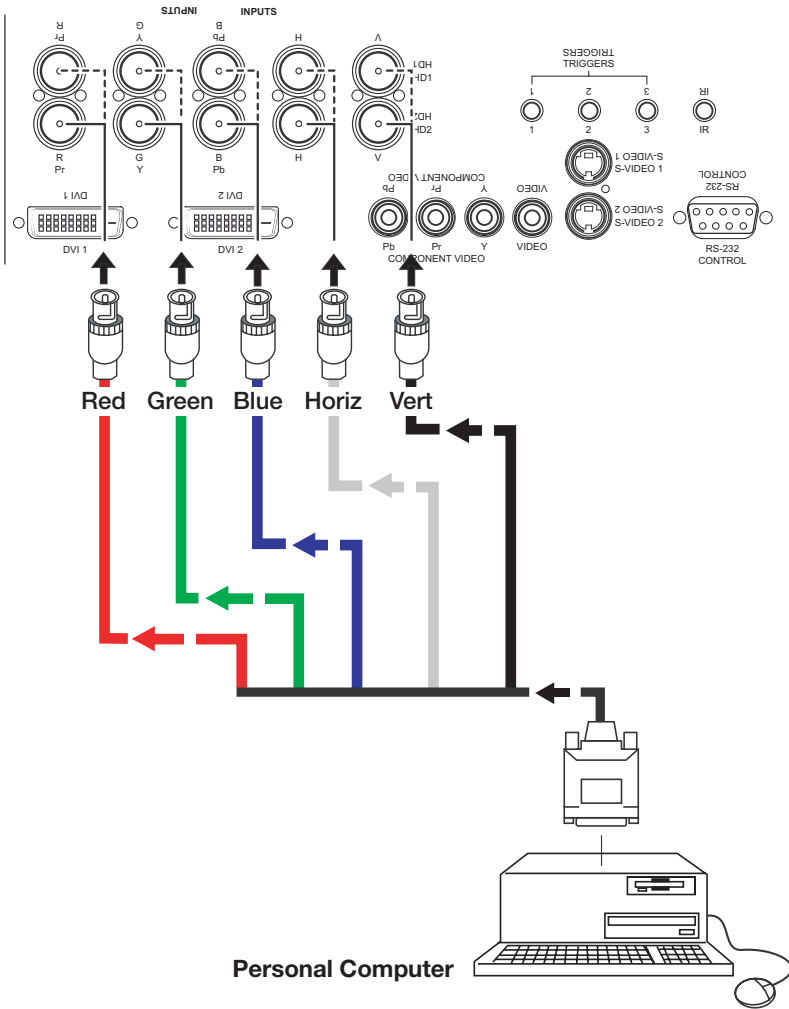

**Figure 3-8. Analog RGB Connections**

**Composite/S-Video/Component Video Connections:** See Figure 3-9.

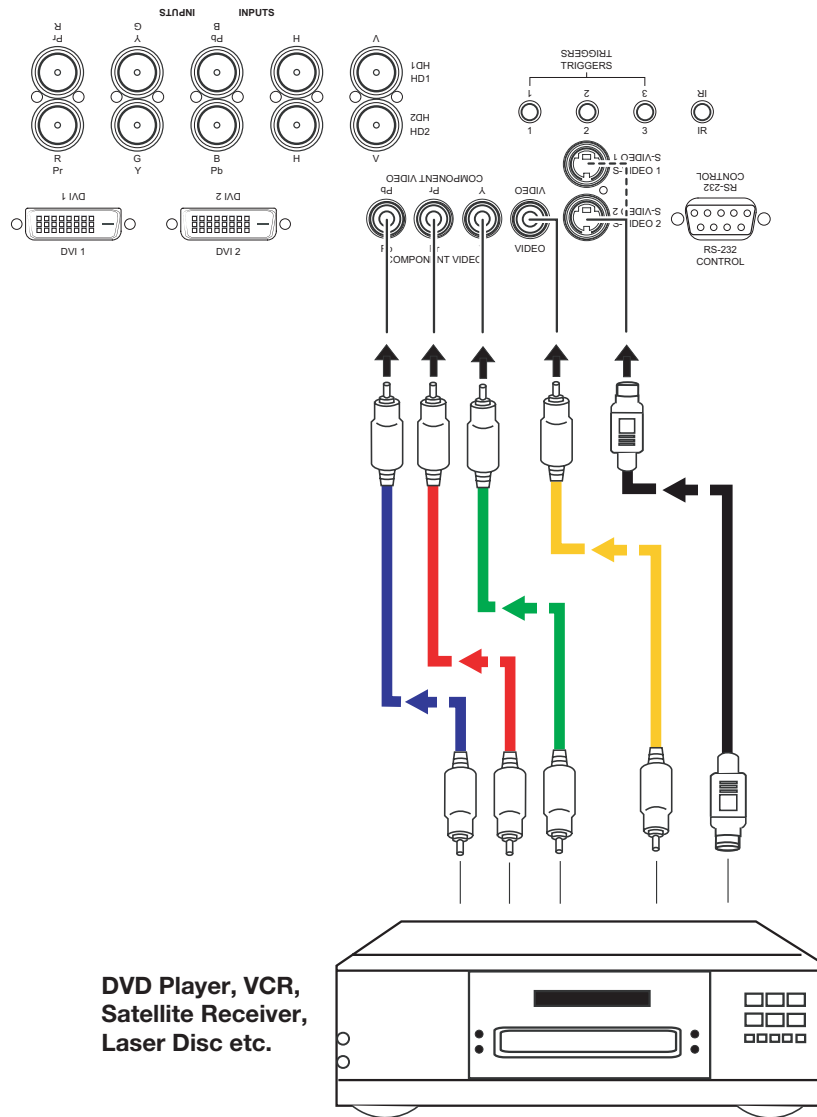
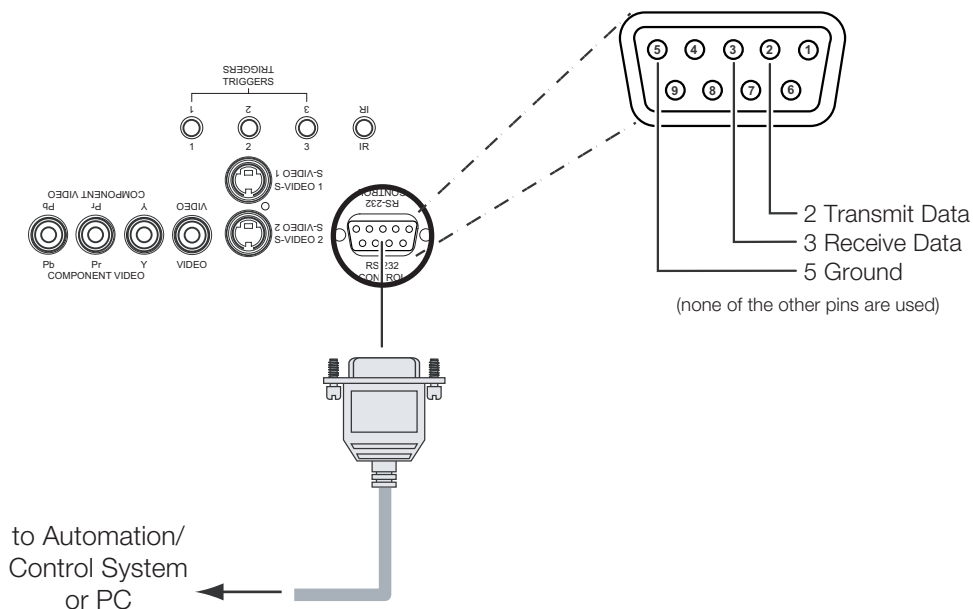

**Figure 3-9. Composite, S-Video and Component Video Connections**

Use a standard, 9-pin RS-232 cable to connect a PC or home theater control/automation system (if present) to the RS-232 CONTROL port on the VX-2ix; see Figure 3-10.

◀ **RS-232 Controller Connection**

For more information about using this connection, refer to **Serial Communications** on page 51.



**Figure 3-10. RS-232 Control System Connection**

If your VX-2ix is equipped with a CineWide with AutoScope system, use the cable supplied with the AutoScope Lens Motor to connect the motor to a 12-Volt trigger output as shown in Figure 3-11.

◀ **Connecting 12-Volt Trigger Outputs to External Theater Equipment**

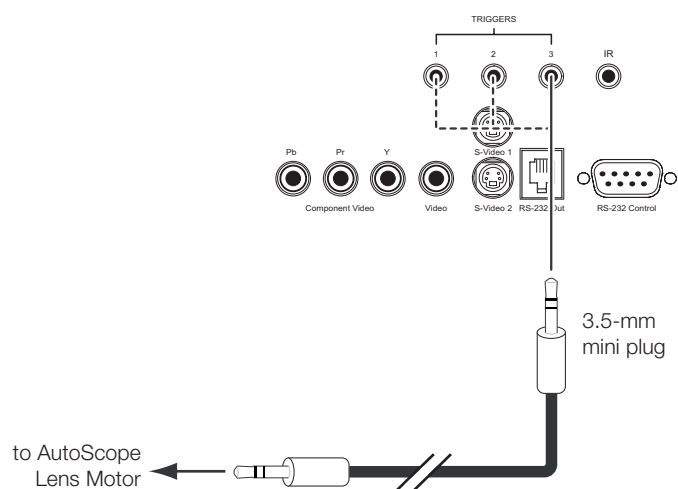

**Figure 3-11. Connecting the 12-Volt Trigger Output to the AutoScope Lens Motor**

If your home theater contains a retractable screen, screen mask or other 12-Volt trigger-activated equipment, connect it to a 12-Volt trigger output as shown in Figure 3-12.

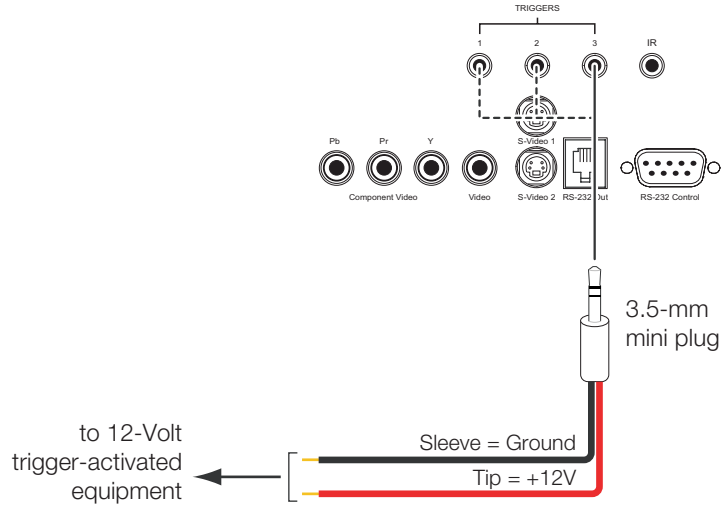

**Figure 3-12. Connecting a 12-Volt Trigger Output to Other Equipment**

**Connecting to AC Power** ➤

Plug the female end of the power cord into the AC receptacle on the rear of the VX-2ix (AC 100V ~ 240V). Then, connect the other end to your AC power source.

**AutoScope Lens Motor:** With AutoScope-equipped projectors, an additional power cord is provided for the lens motor. Plug the female end of the AC power cord into the AC input on the rear of the lens motor assembly. Connect the other end to a 110 VAC power source.



**Caution**

*The input voltage to the AutoScope lens motor must be between 100 and 120 VAC. **Do not connect the AutoScope lens motor to a 200-240 VAC power source!***

# 4. Operation

1. Turn on your source components.
2. Turn on the main power switch on the projector.
3. If this is an AutoScope-equipped projector, turn on the main power switch at the rear of the AutoScope lens motor. The lens motor power switch is located next to the AC input.
4. Press the **ON** button on the remote control – or the **POWER** button on the VX-2ix rear panel – to turn on the projector. The vacuum fluorescent display on the VX-2ix rear panel briefly displays “Starting Display.”
5. When the projector is ready for use, the fluorescent display indicates the active source, signal format (NTSC or PAL), input resolution and aspect ratio; for example:

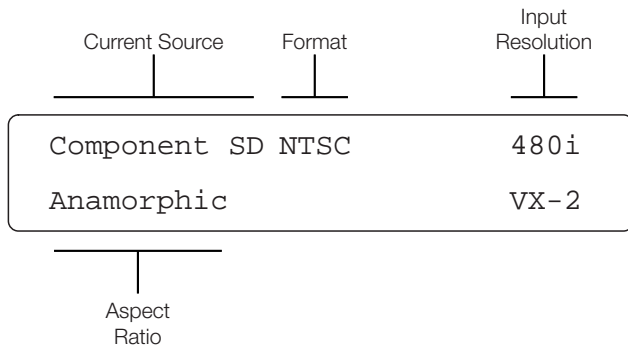

By default, the VX-2ix is configured for a “floor/front” installation, in which the projector is installed upright and in front of the screen. If it is installed behind the screen and/or mounted on a ceiling, you must change the picture orientation. To do this:

1. Press **MENU** and enter the Service Menu passcode.
2. Select Service from the Main Menu.
3. Select Display Device from the Service Menu.
4. Select Installation from the Display Device menu.
5. Choose Floor/Rear, Ceiling/Front or Ceiling/Rear, to match the installation method.



**Note**

*You must enter a passcode to access the Service menu.*

## 4.1 Turning on the Power

## 4.2 Adjusting the Picture Orientation

---

### 4.3 Lens Adjustments

To access the motorized lens controls, select Display Device from the Service Menu, then select Lens from the Display Device menu. The Lens menu gives you a great deal of control over the picture size, position and focus:

- Focus** ➤ To focus the projected image, use the cursor buttons to highlight “In” or “Out.” Then, press and hold the **ENTER** button.
  
- Zoom** ➤ To make the picture smaller (zoom out), use the cursor buttons to highlight the minus sign (-). Then, press and hold the **ENTER** button.  
  
To enlarge the picture (zoom in), use the cursor buttons to highlight the plus sign (+). Then, press and hold the **ENTER** button.
  
- Shift** ➤ To change the projected image position, use the cursor buttons to highlight “Left,” “Right,” “Up” or “Down.” Then, press and hold the **ENTER** button to shift the image in that direction.

---

### 4.4 Using the On-Screen Menus

Press the **MENU** button on either the remote control or the rear panel to display the Main Menu.

To select a menu item, use the ▲ and ▼ buttons on either the remote control or the rear panel to highlight it. Press **ENTER** to confirm your selection.

The VX-2ix OSD menus are arranged hierarchically, as shown in Figure 4-1.



<b>Input Source</b>	Composite	<b>Calibration</b>	ISF Night - Display Color	Gain	
	S-Video 1		ISF Night - Input Image	Offset	
	S-Video 2		ISF Night - Input Color	Gamma	
	Component SD		ISF Day - Display Color	Lamp Power	
	HD/RGB 1		ISF Day - Input Image	Color Temp	
	HD/RGB 2		ISF Day - Input Color	Brightness	
	DVI 1		Save ISF Settings	Contrast	
DVI 2	Output Shift		Color		
<b>Aspect Ratio</b>	Anamorphic		<b>Service</b>	ISF Night - Input Image	Tint
	Standard 4:3			ISF Day - Display Color	Sharpness
	Letterbox			ISF Day - Input Image	Gain
	VirtualWide			ISF Day - Input Color	Offset
	Cinema			ISF Night - Input Color	Chroma Delay
	Virtualwide 2.35			Splash Configure	Phase
<b>Picture</b>	Brightness			ISF Night - Input Color	Noise Filter
	Contrast			ISF Day - Display Color	Gain
	Color			ISF Day - Input Image	Offset
	Tint			ISF Day - Input Color	Gamma
	Sharpness			ISF Night - Input Image	Lamp Power
<b>Input Position</b>	Left/Right			ISF Night - Input Color	Color Temp
	Up/Down			ISF Day - Display Color	Brightness
	Width	ISF Day - Input Image		Contrast	
	Height	ISF Day - Input Color		Color	
<b>ISF Presets</b>	Overscan	ISF Night - Input Image		Tint	
	Recall ISF Night	ISF Day - Input Color		Sharpness	
	Recall ISF Day	ISF Day - Display Color		Gain	
	Recall/Save Custom 1	ISF Day - Input Image		Offset	
	Recall/Save Custom 2	ISF Day - Input Color		Chroma Delay	
<b>Information</b> (read-only)	Reset Custom 1 & 2 to Factory Default	ISF Night - Input Color		Phase	
	Serial Number	ISF Day - Display Color	Noise Filter		
	Hardware	ISF Day - Input Image	Gain		
	Firmware	ISF Day - Input Color	Offset		
<b>Service</b>	Date	ISF Night - Input Image	Gamma		
	Test Video	ISF Day - Display Color	Lamp Power		
	Input Names	Grey Bars 1	ISF Day - Input Image	Color Temp	
		Grey Bars 2	ISF Night - Input Color	Brightness	
		Color Bars 1	ISF Day - Input Color	Contrast	
		Color Bars 2	ISF Night - Input Image	Color	
	Remote Control	Rename, Restore or Save	ISF Day - Display Color	Tint	
		Primary	ISF Day - Input Color	Sharpness	
	Display Device	Secondary	ISF Night - Input Color	Gain	
		Installation	ISF Day - Display Color	Offset	
			Lamp Hours (View/Reset)	ISF Day - Input Image	Gamma
		Lens	Picture Orientation	ISF Day - Input Color	Lamp Power
			Focus	ISF Night - Input Image	Color Temp
			Zoom	ISF Day - Display Color	Brightness
		Diagnostics	Shift	ISF Day - Input Image	Contrast
			Red Only	ISF Night - Input Color	Color
			Green Only	ISF Day - Display Color	Tint
			Blue Only	ISF Day - Input Color	Sharpness
			75 IRE Color Bars	ISF Night - Input Image	Gain
			100 IRE Color Bars	ISF Day - Display Color	Offset
			Horiz. Grey Ramp	ISF Day - Input Image	Chroma Delay
Vert. Grey Ramp	ISF Night - Input Color		Phase		
Checkerboard	ISF Day - Input Color	Noise Filter			
Alignment Grid	ISF Day - Display Color	Gain			
HD Format	HD/RGB 1	ISF Day - Input Image	Offset		
	HD/RGB 2	ISF Night - Input Image	Gamma		
	ADC Bandwidth	ISF Day - Display Color	Lamp Power		
	YPbPr Input Resolution	ISF Day - Input Color	Color Temp		
Triggers	Auto, 75 MHz, 150 MHz or 300 MHz	ISF Night - Input Color	Brightness		
	Auto, 480i/p, 576i/p, 720p or 1080i	ISF Day - Display Color	Contrast		
Miscellaneous	1 / 2 / 3 / Save	ISF Day - Input Image	Color		
	Language	ISF Night - Input Image	Tint		
	Menu Mode	ISF Day - Input Color	Sharpness		
	Timeout	ISF Day - Display Color	Gain		
	Side Bar Color	ISF Day - Input Color	Offset		
Resolution	Film Mode (SD src. only)	ISF Night - Input Color	Chroma Delay		
	800x600 ... 1400x1050	ISF Day - Display Color	Phase		
System Reset	480i ... 720p ... 1080i	ISF Day - Input Image	Noise Filter		
	Restore Saved Settings	ISF Night - Input Image	Gain		
OSD Position	OSD Position	ISF Day - Display Color	Offset		
	OSD Position	ISF Day - Input Color	Gamma		

**Note:** Virtualwide 2.35 is available only on VX-2ix projectors equipped with the CineWide option (secondary anamorphic lens).

Figure 4-1. VX-2ix OSD Menu Structure

**Main Menu** ➤

The Main Menu is the starting point for accessing all projector functions.

(The Calibration and Service menus are hidden and not accessible until you enter a passcode.)

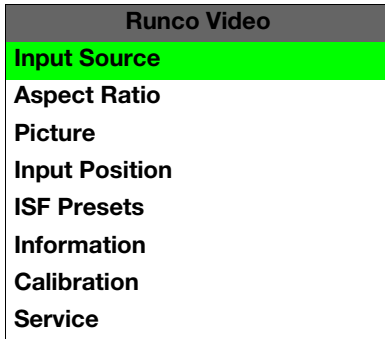

**Input Source** ➤

From the Main Menu, select Input Source to choose a video signal source.

The active source is indicated by an arrow (>) to its left; in the example at left, Composite is the active source.

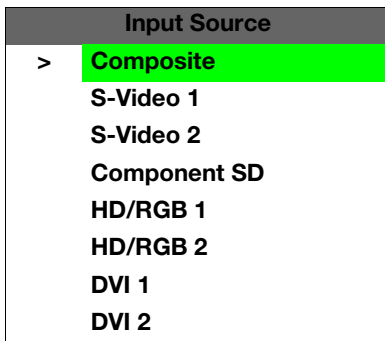

**Aspect Ratio** ➤

To change the aspect ratio (size and shape) of the projected image, select Aspect Ratio from the Main Menu and press **ENTER**. Select the appropriate aspect ratio for the type of program material being viewed; refer to Table 4-1.

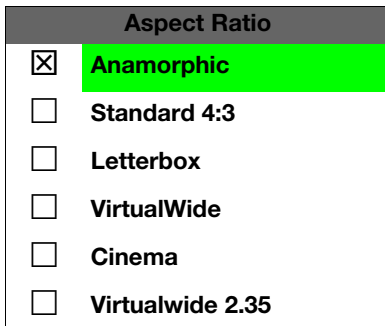

The currently-selected aspect ratio is indicated by a “☒” to its left; in the example at left, Anamorphic is selected.



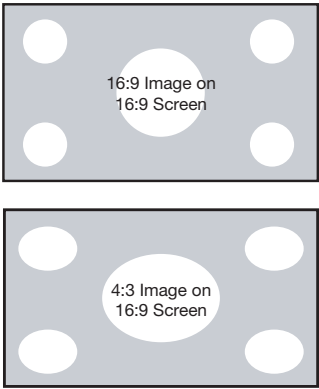
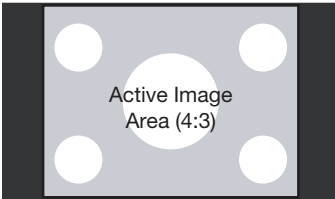

**Note**

*The aspect ratio selection is automatically saved for each input and resolution.*

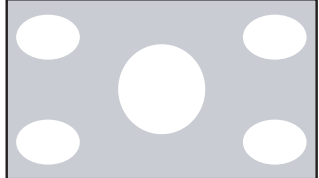
**Table 4-1. Aspect Ratio Settings**

Aspect Ratio	Remote Control Key	Description	
Anamorphic	ANA		<p>Select Anamorphic to view 16:9 DVDs and HDTV programs in their native aspect ratio. 4:3 images are stretched horizontally to fit a 16:9 screen.</p>
Standard 4:3	4X3		<p>Standard 4:3 scales the input signal to fit in the center of the 16:9 screen. 4:3 is the aspect ratio used by computer monitors, standard television programming and most VHS video cassettes.</p>
Letterbox	LET BOX		<p>In Letterbox mode, the image is stretched vertically; the top and bottom portions are “blacked off.” Letterbox is best suited for viewing LaserDisc movies or non-anamorphic DVDs on a 4:3 screen.</p>
VirtualWide	V-WIDE		<p>VirtualWide scales a 4:3 image NON-linearly (more on the sides than in the center) to fit a 16:9 screen.</p>

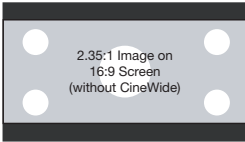
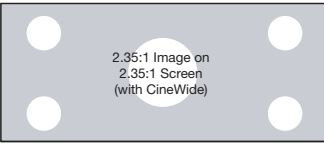
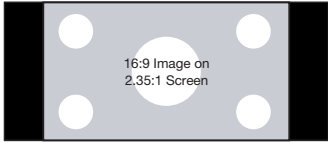
**Table 4-1. Aspect Ratio Settings (continued)**

Aspect Ratio	Remote Control Key	Description	
Cinema	CINEMA	 <p>2.35:1 Image on 16:9 Screen (without CineWide)</p>  <p>2.35:1 Image on 2.35:1 Screen (with CineWide)</p>	<p>Select Cinema to view 2.35 source material in its native aspect ratio.</p> <p>With a 16:9 screen and a non-CineWide projector (no anamorphic lens), the upper and lower portions of the screen are masked, but the geometry of the active image area is unchanged.</p> <p>With a 2.35:1 screen and a CineWide-equipped projector, the VX-2ix vertically stretches the 2.35 image so that the active image area fills the 16:9 chip surface, eliminating the black bars. The secondary anamorphic lens then stretches the image back to 2.35:1.</p>
Virtualwide 2.35	SVC	 <p>16:9 Image on 2.35:1 Screen</p>  <p>16:9 Image on 2.35:1 Screen with VirtualWide 2.35</p>	<p>A 16:9 image is scaled NON-linearly (more on the sides than in the center) to fit a 2.35:1 screen.</p> <p>Virtualwide 2.35 is available only on CineWide-equipped VX-2ix projectors.</p>

Use the controls in the Picture Menu to calibrate your VX-2ix for optimum picture quality.

The VX-2ix has been designed to incorporate setup and calibration standards established by the Imaging Science Foundation (ISF). The ISF has developed carefully crafted, industry-recognized standards for optimal video performance and has implemented a training program for technicians and installers to use these standards to obtain optimal picture quality from Runco video display devices. Accordingly, Runco recommends that setup and calibration be performed by an ISF certified installation technician.

All signal types require separate processing. Therefore, you need to calibrate each input separately.

◀ **Picture**

Picture
<b>Brightness</b>
<b>Contrast</b>
<b>Color</b>
<b>Tint</b>
<b>Sharpness</b>



**Note**

*When you change a picture quality setting, save the change to a preset afterwards. Otherwise, the change will be lost when a different input is selected. (Picture quality settings are saved for each input separately.) For information about saving settings, refer to **ISF Presets** on page 37.*

Although it may be possible to obtain satisfactory picture quality using the naked eye and regular program material, Runco recommends using the following calibration tools for best results:

- External test pattern source – Ovation Multimedia, Digital Video Essentials or AVIA test DVD or equivalent.
- A blue filter (provided with many test DVDs), for color level and tint adjustments.

Connect your test pattern source to the input that you are calibrating and proceed as follows. **Perform the adjustments in the order listed here.**

**Brightness:** On your external test pattern source, select a PLUGE pattern. (PLUGE is an acronym for “Picture Line-Up Generation Equipment.”) Figure 4-2 shows a typical PLUGE pattern.

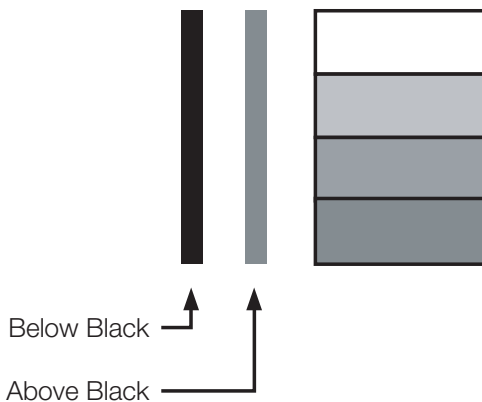

**Figure 4-2. Typical PLUGE Pattern for Adjusting Brightness**

PLUGE patterns vary but generally consist of some combination of black, white and gray areas against a black background. The example above includes two vertical bars and four shaded boxes.

Select Brightness from the Picture menu and press **ENTER**. Adjust the brightness so that:

- The darkest black bars disappear into the background.
- The dark gray areas are barely visible.
- The lighter gray areas are clearly visible.
- The white areas are a comfortable level of true white.
- The image contains only black, gray and white (no color).

**Contrast:** On your external test pattern source, select a stepped, gray-bar pattern like the one shown in Figure 4-3.



**Figure 4-3. Typical Gray Bar Pattern for Adjusting Contrast**

Select Contrast and press **ENTER**. Adjust the contrast to a point just below which the white rectangle starts to increase in size.



**Note**

*Brightness and contrast controls are interactive. A change to one may require a subtle change to the other in order to achieve the optimum setting.*

**Color Saturation:** On your external test pattern source, select a color bar pattern like the one shown in Figure 4-4.

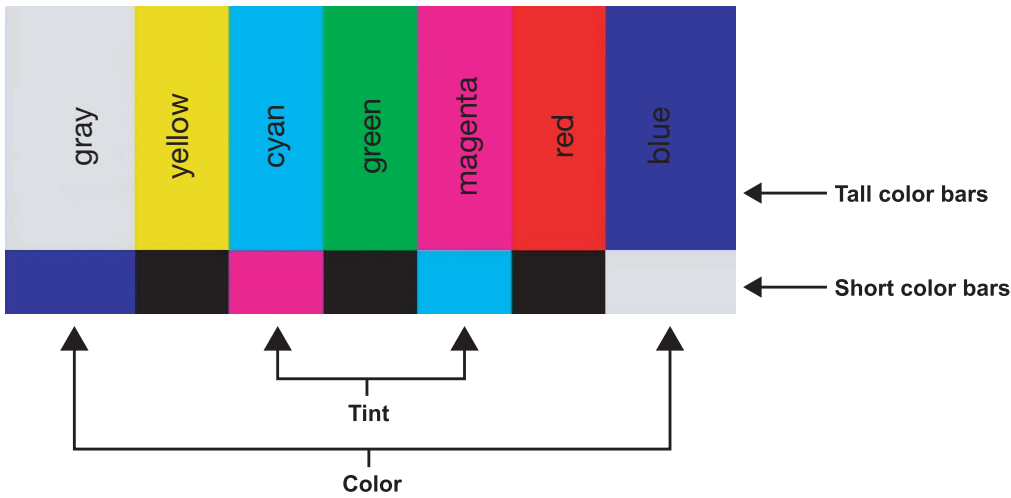

**Figure 4-4. Typical Color Bar Pattern for Adjusting Color Saturation and Tint**

Select Color and press **ENTER**. While looking at the color bar pattern through a blue filter, adjust the color saturation level until the outermost (gray and blue) color bars appear to be a single shade of blue:

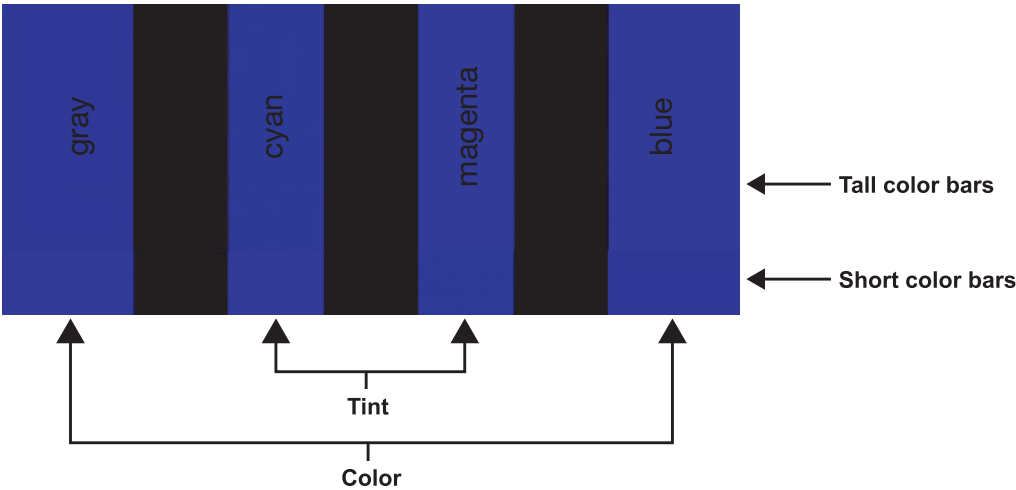

**Tint:** Tint or “hue” is essentially the ratio of red to green in the color portion of the image. When tint is decreased, the image appears redder; when it is increased the image appears greener. To set the tint, select Tint and press **ENTER**. While looking at the color bar pattern through a blue filter, adjust the tint level until the cyan and magenta color bars (on either side of the green bar) appear to be a single shade of blue.



**Note**

*Like the brightness and contrast controls, the color and tint controls are interactive. A change to one may require a subtle change to the other in order to achieve the optimum setting.*

**Sharpness:** “Sharpness” is the amount of high-frequency detail in the image. To adjust sharpness, select Sharpness from the Picture menu and press **ENTER**. On your external test pattern source, select a pattern like the one shown in Figure 4-5. Adjust as needed, looking for white edges around the transitions from black to gray and differently-sized lines in the “sweep” patterns at the top and bottom. Lower the sharpness setting to eliminate them.

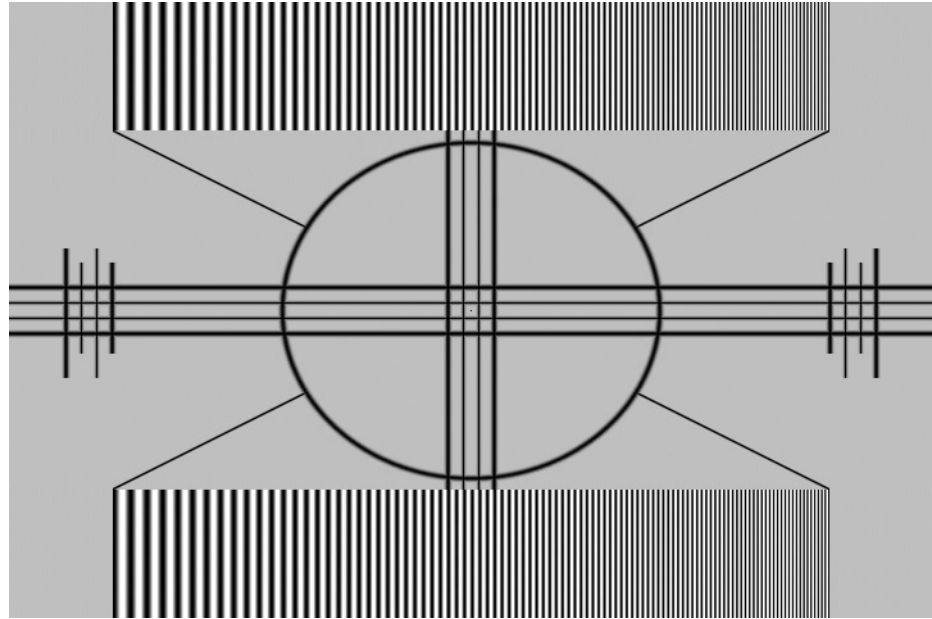

**Figure 4-5. Typical Test Pattern for Adjusting Sharpness**

**Input Position** ➤

Use the controls in the Input Position Menu to fine-tune the aspect ratio and image position for the current source.

Input Position
Left/Right
Up/Down
Width
Height
Overscan



**Note**

*The input position settings are automatically saved for each input and resolution.*

**Left/Right:** Select Left/Right from the Input Position menu to shift the projected image horizontally. Use the right or up cursor button to shift the image to the right; use the left or down button to shift it to the left.

**Up/Down:** Select Up/Down from the Input Position menu to shift the projected image vertically. Use the right or up cursor button to shift the image upward; use the left or down button to shift it downward.

**Width:** Select Width from the Input Position menu to change the projected image width. Use the right or up cursor button to increase the width; use the left or down button to decrease it.

**Height:** Select Height from the Input Position menu to change the projected image height. Use the right or up cursor button to increase the height; use the left or down button to decrease it.



**Overscan:** Image Overscan pushes the outside edge of the active picture area of the video signal out beyond the edge of the display area.

Some television programs are produced based on the assumption that older television sets may not display the outer edges of the broadcast picture area. Overscan effectively trims away these inactive, outer edges and enlarges the remaining portion of the image to fill the display area.

Select from 1% to 10% of Overscan, as desired.

For HDTV, DVDs and other video sources, Overscan is generally not necessary or desirable.

For each input, the VX-2ix lets you save image quality settings as presets that you can recall at a later time. You can create up to four presets per input and resolution. Use the ISF Presets menu to recall saved image presets, or to save image settings in the “Custom 1” or “Custom 2” memory location. The currently-selected preset is indicated by a “☒” to its left; in the example shown here, ISF Night is selected.

You should save changes to any of the following settings to a preset; otherwise they will be lost when a new input source or resolution is selected:

- Brightness
- Contrast
- Color saturation
- Tint
- Sharpness

To reset the Custom 1 and Custom 2 image presets to their factory defaults, select Factory Default and press **ENTER**.

Select Information from the Main Menu to see information that uniquely identifies your projector: its serial number, the installed hardware and firmware versions and the firmware version build date. Should you ever need to contact Runco Technical Support, this information will help them answer your questions or resolve product performance issues.

◀ **ISF Presets**

ISF Presets	
<input checked="" type="checkbox"/>	<b>ISF Night</b>
<input type="checkbox"/>	ISF Day
<input type="checkbox"/>	Custom 1 <b>Save</b>
<input type="checkbox"/>	Custom 2 <b>Save</b>
<b>Factory Default</b>	

◀ **Information**

Information	
<b>Serial Number</b>	
<b>Hardware</b>	0
<b>Firmware</b>	0002.012A
<b>Date</b>	Mar 29 2006

**Calibration** ➤

Use the Calibration menu to perform advanced picture quality adjustments. **This menu should be used by ISF-certified technicians only.**

Calibration
ISF Night
<b>Display Color</b>
Input Image
Input Color
ISF Day
Display Color
Input Image
Input Color
Save ISF Settings
Output Shift
Splash Configure
OSD Position



**Note**

*You must enter a passcode to access the Calibration menu.*

To recall the ISF Night or ISF Day settings, select “ISF Night” or “ISF Day” from the ISF Presets menu (page 37).

**ISF Night - Display Color:** Use the Display Color settings to adjust the color balance at the projector output. These settings are saved independently for each input.

- **Gain:** Use the Gain controls to correct color imbalances in the bright areas of the image. A good way to do this is to use a test pattern consisting mostly of solid white areas, such as an 80 IRE “window” pattern. If the white areas contain traces of red, green or blue, decrease the Gain for that color.
- **Offset:** Use the Offset controls in the White Balance sub-menu to correct color imbalances in the dark areas of the image. A good way to do this is to use a test pattern consisting mostly of dark gray areas, such as a 30 IRE “window” pattern. If the gray areas contain traces of red, green or blue, decrease the Offset for that color.
- **Gamma:** “Gamma” is a global setting that determines how gray shades are displayed between minimum input (black) and maximum input (white) for all signals. A good gamma setting helps to optimize blacks and whites while ensuring smooth transitions for the “in-between” values utilized in other grays. Unlike “Brightness” and “Contrast” controls, the overall tone of your images can be lightened or darkened without changing the extremes and all images will be more vibrant while still showing good detail in dark areas.

In all but the most unusual situations, the appropriate “Color Temp” selection (see below) will produce accurate colors and a satisfying contrast level. However, it is sometimes necessary to adjust the red, blue and green gamma curves individually. To do this, select Gamma from the Display Color sub-menu and use the left- and right-arrow buttons to manipulate the on-screen slidebars.

- **Lamp Power:** Select Lamp Power from the Display Color Menu to adjust the lamp output level. You can choose to run the lamp as bright as possible (“1”; this is the default setting) or you can choose the lower setting (“0”). Generally, lower lamp output can prolong the life of the lamp, but decreases brightness.
- **Color Temp:** Select Color Temp from the Display Color menu to adjust the color temperature. The default setting is appropriate for most situations. Higher settings produce a “bluer” picture.

**ISF Night - Input Image:** The Input Image controls are similar to those in the Picture menu, but are accessible only by entering the Calibration menu passcode. This makes it possible to restore the picture quality settings to what they were when the projector was installed, simply by recalling the “ISF Night” preset.

---

**ISF Night - Input Color:** The Input Color controls are similar to those in the Display Color menu (see above), but adjust the color balance of the incoming signal. These settings are also saved independently for each input.

- **Gain/Offset:** Refer to ***ISF Night - Display Color***, above.
- **Chroma Delay:** use the Chroma Delay control to correct a mis-aligned image from a Composite, S-Video or Component video source. Chroma delay in an image causes color shifts to occur to the left of the vertical edge transitions, producing artificial shadows or a “halo” effect. If necessary, adjust this setting to eliminate them.
- **Phase:** Adjust the phase if the image (usually from an RGB source) shows shimmer or “noise.” Pixel phase adjusts the phase of the pixel sampling clock relative to the incoming signal. The effect of this control is similar to that of a tracking control on a VCR.

For best results, use a good test pattern such as a smooth gray consisting of a clear pattern of black and white pixels, or a similar “half on, half off” graphic image. (You may notice that you can stabilize the image at more than one point. Use either setting in this case.)

- **Noise Filter:** To apply noise filtering to the input signal, select Noise Filter from the Input Color menu. The Noise Filter is useful for clearing up noisy images from 480i video sources.

Use the left- or right-arrow buttons to select the desired amount of noise reduction, keeping in mind that higher settings (which reduce high frequencies) may also “soften” the image.

**ISF Day - Display Color:** Refer to ***ISF Night - Display Color***.

**ISF Day - Input Image:** Refer to ***ISF Night - Input Image***.

**ISF Day - Input Color:** Refer to ***ISF Night - Input Color***.

**Save ISF Settings:** Whenever you make a change to the ISF settings, you should always save it. Select Save ISF Settings from the ISF Calibration menu to do this. In the event you ever have to perform a System Reset, you can restore the saved ISF settings by selecting Restore Saved Settings in the Service menu. (System Reset and Restore Saved Settings are described on page 43.)

**Output Shift:** The controls in the Output Shift menu are similar to those in the Input Position menu, except that they change the characteristics of the output signal. These settings are saved independently **for each aspect ratio**.

**Splash Configure:** Use the Splash Configure menu to customize the appearance of the start-up message that appears on the vacuum fluorescent display upon power-up. You can have the VX-2ix display the owner’s name, your name, the phrase “ISF Calibrated” and/or any other string, up to 20 characters in length.

Use the up or down cursor button to select a character. Use the right and left cursor buttons to change the cursor position. Press **MENU** when you have finished entering text. Then, check the “Splash Enable” box to have the VX-2ix display the information you enter here when it is turned on.

**OSD Position:** Select OSD Position, press **ENTER** and use the arrow buttons to change the size and position of the OSD controls.

**Service** ► Use the Service menu to access advanced projector configuration settings. **This menu should be used by ISF-certified technicians only.**

Service	
<b>Test Video</b>	
Input Names	
Remote Control	
Display Device	
HD Format	
Triggers	
Miscellaneous	
Resolution	
System Reset	
Restore Saved Settings	



**Note**

*You must enter a passcode to access the Service menu.*

**Test Video:** Select Test Video from the Service Menu to access the internal test patterns on the VX-2ix. Four patterns are available, consisting of white/gray or colored bars.

Press **MENU** to exit test pattern mode.

Input Names	
	<b>Restore</b>
<b>Composite</b>	Composite
S-Video 1	S-Video 1
S-Video 2	S-Video 2
Component SD	Component SD
HD/RGB 1	HD/RGB 1
HD/RGB 2	HD/RGB 2
DVI 1	DVI 1
DVI 2	DVI 2
Save	

**Input Names:** You can give each VX-2ix input a descriptive name. For example, you may want to change the default input name to the type of source component connected to it: “VCR,” “DVD,” “Laptop” et cetera. Composite, S-Video and Component SD input names can be up to 12 characters long; the others can be up to eight characters long.

To edit an input name, select Input Names from the Service menu. Press ▲ or ▼ to select an input and press **ENTER**. Use the ▲ or ▼ buttons to change a character; press ◀ or ▶ to select a character to change. When you have finished editing the input name, press **MENU**.

To restore the default input name, press ▼ repeatedly to highlight that input name in the “Restore” column. Then, press **ENTER**.

To save input names so that they can be restored after a System Reset (described on page 43), press ▼ repeatedly to highlight “Save.” Then, press **ENTER**.



**Note**

*The ▼ button takes you from top to bottom in the left column, then from top to bottom in the right column. To highlight “Save,” scroll through both columns.*

**Remote Control:** The Remote Control menu shows you the primary and secondary infrared (IR) codes to which the VX-2ix will respond. By default, both are set to 17. You can change these codes if either:

- Another device in the theater (a DVD player, for example) is responding to commands from the VX-2ix remote control in ways that are unpredictable or undesirable.
- You have multiple VX-2ix projectors and want to control them independently, as opposed to broadcasting commands from a single remote to all of them. In this scenario, you can use multiple remotes programmed to use different IR codes. Or, you can use a single remote and change the IR code as needed to address a specific projector.



**Tip**

Use the rear-panel keypad to change a projector IR code. Then, change the code sent by the remote to match as described below.



**Note**

Do not change the "Type" setting in this menu.

When you change a remote code on the VX-2ix, you must re-program your remote control to send that same code. To do this:

1. Using a straightened paper clip or similar object, press and hold the **CODE** button on the remote control for approximately three seconds, or until the red LED on the remote lights solid red.
2. Enter a new two-digit code between 00 and 31 inclusive. Include a leading zero for single-digit codes; for example, enter 9 as "09."
3. The LED turns off to confirm the code change. If you enter an invalid code, the LED flashes for three or four seconds. Try again, entering a valid code.

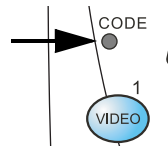

**Display Device:** The options in the Display Device menu allow you to change the picture orientation, reset the lamp timer, perform lens adjustments and access additional test patterns.

- **Installation:** Select Installation from the Display Device menu to change the picture orientation to suit the method of installation (Floor Front, Floor Rear, Ceiling Front or Ceiling Rear).

This menu page also displays the number of hours that the lamp has been in service, and lets you reset the counter (which is recommended after you replace the lamp; refer to **Lamp Replacement** on page 45).

- **Lens:** Select Lens from the Display Device menu to access the motorized lens controls. Refer to **Lens Adjustments** on page 28.
- **Diagnostics:** Select Diagnostics from the Service menu to access additional test patterns for calibration or measurement purposes:
  - Select **Red, Green** or **Blue** to display only the selected color (simulating a filter of that color).
  - Select **75** or **100** to display color bars (75 IRE or 100 IRE).
  - Select **Horz** or **Vert** to display a horizontal or vertical gray ramp.
  - Select **Checks** to display a 15-segment checkerboard pattern.
  - Select **Align** to display a white grid against a black background (useful for verifying proper image or screen alignment).

HD Format	
HD/RGB 1	Auto
HD/RGB 2	Auto
ADC Bandwidth	Auto
YPbPr Input Resolution	

**HD Format:** If the characteristics of the incoming signal on the HD1 or HD2 inputs are known, select HD Format from the Service menu and set them as described below. Doing so can reduce the time it takes the VX-2ix to switch from HD to 480i signals or vice versa.

This is generally not necessary unless the VX-2ix – for whatever reason – has difficulty determining the color space (RGB or YUV), bandwidth or resolution of the incoming HD signal. In most situations, the **Auto** settings work well.

- **HD/RGB 1 and HD/RGB 2 (Color Space):** Select Auto, RGB or YUV.
- **ADC Bandwidth:** Select Auto, 75 MHz, 150 MHz or 300 MHz.
- **YPbPr Input Resolution:** Select Auto or specify the input resolution, if known: 480i, 480p, 576i, 576p, 720p or 1080i.

**Triggers:** Select Triggers from the Service menu to configure the 12-volt trigger outputs. You can assign one or more trigger outputs to each aspect ratio. Those triggers are then activated by selecting that aspect ratio.

If your projector is equipped with the Runco CineWide with AutoScope system, assign at least one trigger output (the same one to which the lens motor is connected) to the Cinema and Virtualwide 2.35 aspect ratios.

To save the trigger settings so that they can be restored after a System Reset (described below), press ▼ repeatedly to highlight “Save.” Then, press **ENTER**.

**Miscellaneous:** Select Miscellaneous from the Service menu to set the following options:

- **Language:** Select Language from the Miscellaneous menu and press the up- or down-arrows to select the OSD Language (English, French, Spanish or German).
- **Menu Mode:** This is the manner in which the OSD menus appear and disappear when you press MENU. Choose one of the following:
  - 0 = No transition; menus abruptly appear and disappear.
  - 1 = Menus fade in and out.
  - 2 = “Checkerboard” dissolve; menus appear and disappear in sections.
  - 3 = “Window shade” effect; menus are drawn on a diagonal from top left to bottom right, and retract in the opposite direction.
- **Timeout - Short/Long:** These settings control how long the OSD menus stay on screen. Select a time-out period of from 2 to 60 seconds.
- **Side Bar Color:** This controls the color of the inactive image area. The range is from -100 (black) to 100 (white).

The inactive image area is on either side of the active image area when using the Standard 4:3 aspect ratio, and above and below the active image area when using the Letterbox aspect ratio.

- **Film Mode:** Enable Film Mode to smooth out moving images from interlaced, standard-definition (SD) sources. In most cases, the VX-2ix detects the proper “pull-down” rate and vertical frequency. However, if your source is jittery and/or tearing you may wish to enable Film Mode to ensure stable processing for that source.

**Resolution:** The VX-2ix defaults to an output resolution of 720p. When using the VX-2ix with a computer or certain HD sources, you may want to force it to use a different output resolution. If so, select Resolution from the Service menu and choose one. Then, press **ENTER** to confirm.

---

**System Reset:** To reset ALL projector and controller settings (including image settings) back to their factory defaults, choose System Reset from the Service menu.

A confirmation message appears, reminding you to save your settings before you perform the reset, so that you can restore them afterwards. If you have done this, select Confirm to continue with the reset. Otherwise, click Back to cancel.

**Caution**

***This action is not undoable. Proceed with caution!*** Before you perform a System Reset, save ALL settings, including “Custom” ISF Presets (page 37), ISF Day/Night presets (page 39), Output Shift settings (page 39), Input Names (page 40) and Trigger settings (page 42).

**Restore Saved Settings:** Following a System Reset, select Restore Saved Settings to apply all previously-saved settings to the projector.

**Notes:**



# 5. Maintenance and Troubleshooting

The lamp should be replaced when it reaches the end of its life (typically 2000 hours), or sooner if a noticeable degradation in brightness occurs. Contact your Runco dealer to obtain a replacement lamp.

## 5.1 Lamp Replacement

1. Turn off the projector and unplug the power cord. Allow the projector to cool down for approximately 45 minutes prior to removing the lamp assembly for replacement.
2. Loosen the four rear Lamp Cover screws and remove the cover.

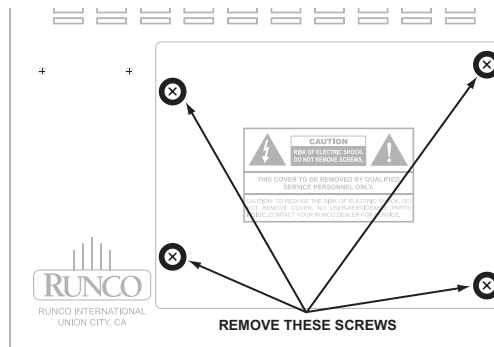

3. Remove the two lamp assembly mounting screws.
4. Grasp the lamp assembly handle and pull gently, removing the lamp module from the projector housing.
5. Install the new lamp module.
6. Replace the lamp cover and re-tighten all screws.
7. Reset the Lamp Hour counter. To do this, select Service from the Main Menu, then Display Device, then Installation. Use the cursor buttons to highlight Reset under "Lamp Hours" and press **ENTER**.

If you need to remove the lens – either to replace it or to prepare the projector for shipment – proceed as follows:

## 5.2 Lens Replacement



**Note**

**Only trained, authorized Runco dealers should attempt to remove or replace a lens. Please read this procedure carefully before doing so.**

*Lens replacement is normally performed at the Runco factory. Field replacement of lenses is generally only required if the projector is re-installed in a new location or the lens has been damaged.*

1. Power down the projector and wait five minutes to allow the lamp to cool.
2. Remove the secondary anamorphic lens, if present.

3. Loosen the captive Phillips screw from the bottom of the front lens decorative bezel.

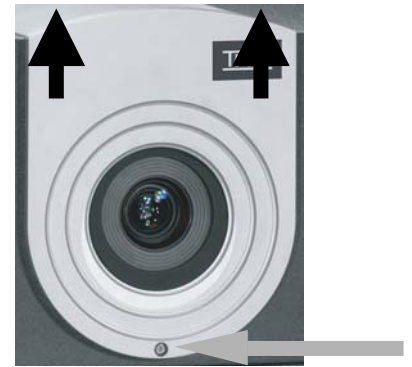

4. Slide the bezel upward to remove it.

5. Remove the foam shield around the front of the lens.



6. Using the red-handled, 3-mm hex driver provided with the projector, loosen the three, captive Allen screws on the outer ring of the lens assembly.

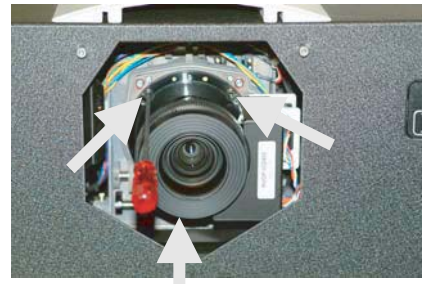

7. Gently pull the lens assembly straight out, just far enough to separate the motor socket connector (on the lens) from the lens mount flange (inside the projector). Then, carefully rotate the lens assembly 90 degrees counter-clockwise (in order to clear the Projector chassis with the Motor Assembly) and remove it.



Note that the lens mount flange has a female socket connector for the lens motor on the right side of the flange.

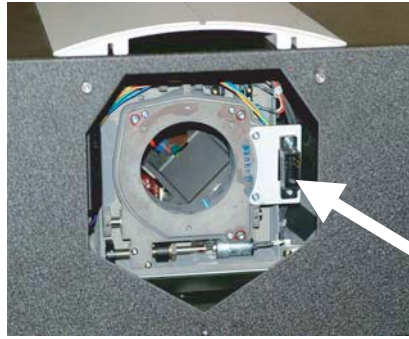

Note that the lens assembly motor has a male socket connector.

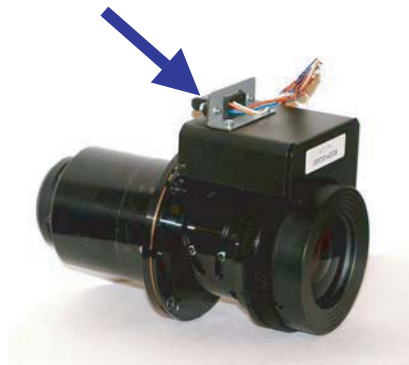

8. Hold the replacement lens assembly with the motor facing upward. **Carefully** insert the back of the lens assembly into the hole in the lens flange.

DO NOT PUSH THE LENS ASSEMBLY ALL THE WAY IN. Only push the lens assembly in far enough so that the front of the lens motor is clearly behind the projector chassis cover.

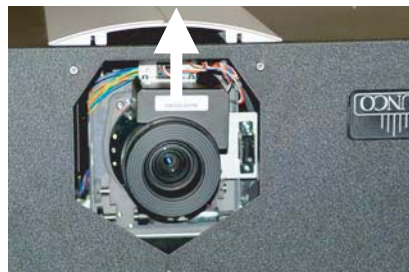

9. Carefully rotate the lens assembly 90 degrees clockwise until the motor socket connector is aligned with the connector on the flange. Then, gently push the lens assembly in until it is seated flush against the flange and the connectors have seated.

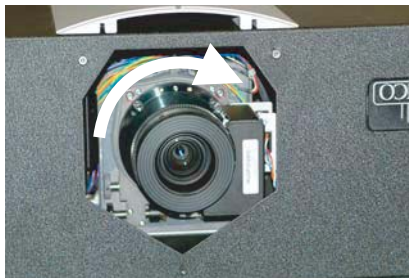

10. Secure the lens assembly to the projector flange with the three Allen screws that you loosened in Step 6.

11. Replace the foam lens shield.

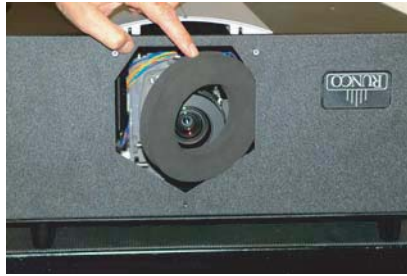

12. Reattach the front lens bezel by sliding the top down onto the two retaining dowels.
13. Tighten the Phillips screw on the bottom of the bezel to secure it.

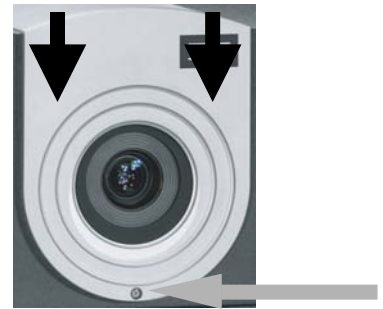

Table 5-1 provides some general guidelines for troubleshooting problems you may encounter with the VX-2ix. If you encounter an issue not described here, please contact Runco Technical Support.

## 5.3 Troubleshooting Tips

**Table 5-1. Troubleshooting Chart**

Symptom	Possible Cause(s)	Solution
The projector does not turn on after initial installation. The power LED lights red after you press the power button.	<ul style="list-style-type: none"> <li>The VX-2ix is not plugged in or the AC outlet is not active.</li> </ul>	<ul style="list-style-type: none"> <li>Ensure that the VX-2ix is plugged in and that the AC outlet is active.</li> </ul>
The projector is on, but there is no video image on-screen.	<ul style="list-style-type: none"> <li>Incorrect source selection.</li> <li>Source component is not turned on.</li> </ul>	<ul style="list-style-type: none"> <li>Select the correct source.</li> <li>Turn on the source.</li> </ul>
A projected image from a DVD is split or otherwise scrambled.	<ul style="list-style-type: none"> <li>DVD player is set to progressive scan mode.</li> </ul>	<ul style="list-style-type: none"> <li>Turn off progressive scan on the DVD player.</li> <li>Connect the DVD player to the HD/RGB 1 or HD/RGB 2 input.</li> </ul>
Image is too bright and/or lacks definition in the bright areas of the image.	<ul style="list-style-type: none"> <li>Contrast is set too high.</li> </ul>	<ul style="list-style-type: none"> <li>Lower the contrast setting.</li> </ul>
Image appears "washed out" and/or dark areas appear too bright.	<ul style="list-style-type: none"> <li>Brightness is set too high.</li> </ul>	<ul style="list-style-type: none"> <li>Lower the brightness setting.</li> </ul>
Colors in the image are swapped; for example, reds appear blue or vice versa.	<ul style="list-style-type: none"> <li>The Red/Pr, Green/Y or Blue/Pb outputs from the source are connected to the wrong inputs on the VX-2ix.</li> </ul>	<ul style="list-style-type: none"> <li>Ensure that the source outputs are connected to the correct VX-2ix input.</li> </ul>
Image geometry is incorrect.	<ul style="list-style-type: none"> <li>Incorrect aspect ratio selection.</li> </ul>	<ul style="list-style-type: none"> <li>Select the aspect ratio that best matches the source image and screen size (refer to Table 4-1).</li> </ul>
The projector will not turn back on after it was powered down, or the image disappears during operation.	<ul style="list-style-type: none"> <li>The projector will not turn on for two minutes after power-down, to protect the lamp.</li> <li>The lamp has failed.</li> </ul>	<ul style="list-style-type: none"> <li>Wait two minutes until the LED at the front of the VX-2ix turns red.</li> </ul>

**Notes:**

# 6. Serial Communications

To interface the VX-2ix with a home theater automation/control system or a PC running terminal emulation software, connect it to your control system or PC as shown in Figure 3-10.

Configure the RS-232 controller or PC serial port as follows: no parity, 8 data bits, 1 stop bit and no flow control. Set the baud rate to 19200, to match that of the VX-2ix RS-232 port.

Serial commands to the VX-2ix take the following form:

- Commands are not case-sensitive.
- For a single command that takes no parameters, type the command followed by a carriage return; for example, to set the aspect ratio to Letterbox, type `LETTERBOX <Enter>`.
- For a single command that takes a parameter, type the command, a space or a comma and the desired value followed by a carriage return; for example, to set the brightness to -10, type `BRIGHTNESS -10 <Enter>` or `BRIGHTNESS,-10 <Enter>`.
- You can also send a string of multiple commands on a single line, separated by commas. For example, `COMPOSITE , BRIGHTNESS 100 , ANAMORPHIC <Enter>` switches to the Composite video input, sets the brightness to 100 and sets the aspect ratio to Anamorphic. Command strings can be up to 255 characters long.



### Note

Avoid combining the `ON` or `POWER 1` commands with other commands on a single line. After sending `ON` or `POWER 1`, allow at least 15 seconds for the projector to power up. Once it does, it will accept and properly execute multiple serial commands.

Table 6-1 lists the RS-232 command set. The “Parameter (min/max)” column shows the valid parameter ranges, or “NA” for commands that take no parameters.

When you enter a valid command, the VX-2ix executes it and acknowledges it with a plus sign on the command line (+ >). When you enter an invalid command – one that is misspelled or followed by values outside the valid range for that command – the VX-2ix ignores it and returns a minus sign (- >).

**Table 6-1. Serial Commands**

Command	Parameter (min/max)	Value Stored?	Description
<b>Power On/Off Commands</b>			
OFF	NA	NA	Turns projector off
ON	NA	NA	Turns projector on
POWER	0/1	NA	Turns projector on and off
POWER?	NA	NA	Returns power status

## 6.1 RS-232 Connection and Port Configuration

## 6.2 Serial Command Syntax

**Table 6-1. Serial Commands (continued)**

Command	Parameter (min/max)	Value Stored?	Description
<b>Input Selection Commands</b>			
COMPONENT	NA	YES	Selects the Component input
COMPOSITE	NA	YES	Selects the Composite video input
DVI1	NA	YES	Selects the DVI 1 input
DVI2	NA	YES	Selects the DVI 2 input
HD1	NA	YES	Selects the RGB HD 1 input
HD2	NA	YES	Selects the RGB HD 2 input
INPUT?	NA	NA	Returns active input
SVIDEO1	NA	YES	Selects the S-Video 1 input
SVIDEO2	NA	YES	Selects the S-Video 2 input
<b>Aspect Ratio Commands</b>			
ANAMORPHIC	NA	YES	Selects the Anamorphic aspect ratio
ASPECT?	NA	NA	Returns current aspect ratio
ASPECTIN?	NA	NA	Returns the input source aspect ratio
ASPECTOUT?	NA	NA	Returns output screen size
CINEMA	NA	YES	Selects the Cinema aspect ratio
LETTERBOX	NA	YES	Selects the Letterbox aspect ratio
OUT169	NA	YES	Sets the output screen to 1.78:1 (16:9)
OUT235	NA	YES	Sets the output screen to 2.35:1
STANDARD	NA	YES	Selects the Standard (4:3) aspect ratio
VIRTUALWIDE	NA	YES	Selects the VirtualWide aspect ratio
VIRTUAL235	NA	YES	Selects the Virtualwide 2.35 aspect ratio



**Table 6-1. Serial Commands (continued)**

Command	Parameter (min/max)	Value Stored?	Description
<b>Picture Adjust Commands</b>			
BRIGHTNESS	-100/100	YES	Sets a value for brightness
BRIGHTNESS?	NA	NA	Returns brightness setting value
CHROMADELAY	-12/12	YES	Sets a value for input color chroma delay
CHROMADELAY?	NA	NA	Returns input color chroma delay setting
COLOR	-100/100	YES	Sets a value for color
COLOR?	NA	NA	Returns color setting value
CONTRAST	-100/100	YES	Sets a value for contrast
CONTRAST?	NA	NA	Returns contrast setting value
FILMMODE	0/1	YES	Sets Film Mode off (0) or on (1)
FILMMODE?	NA	NA	Returns Film Mode setting (0 = off; 1 = on)
FILTER	0/15	YES	Sets a value for input color noise filter
FILTER?	NA	NA	Returns input color noise filter setting
PHASE	0/3	YES	Adjusts phase
PHASE?	NA	NA	Returns phase setting value
SHARPNESS	-6/6	YES	Sets a value for sharpness
SHARPNESS?	NA	NA	Returns sharpness setting value
TINT	-100/100	YES	Sets a value for tint
TINT?	NA	NA	Returns tint setting value
<b>Image Preset Commands</b>			
CUSTOM1	NA	YES	Loads "Custom 1" image preset
CUSTOM2	NA	YES	Loads "Custom 2" image preset
DAY	NA	YES	Loads "ISF Day" image preset
NIGHT	NA	YES	Loads "ISF Night" image preset
PRESET?	NA	NA	Returns currently-selected preset (ISF Day, ISF Night, Custom 1 or Custom 2)

**Table 6-1. Serial Commands (continued)**

<b>Command</b>	<b>Parameter (min/max)</b>	<b>Value Stored?</b>	<b>Description</b>
<b>Input Position Commands</b>			
IHEIGHT	-100/100	YES	Sets the value for input height
IHEIGHT?	NA	NA	Returns input height value
IHPOS	-100/100	YES	Sets a value for horizontal input position
IHPOS?	NA	NA	Returns input horizontal position value
IVPOS	-100/100	YES	Sets a value for vertical input position
IVPOS?	NA	NA	Returns input vertical position value
IWIDTH	-100/100	YES	Sets the value for input width
IWIDTH?	NA	NA	Returns input horizontal width value
OVERSCAN	0/10	YES	Sets the overscan percentage
OVERSCAN?	NA	NA	Returns overscan percentage
<b>Output Shift Commands</b>			
OHEIGHT	-100/100	YES	Sets the value for output height
OHEIGHT?	NA	NA	Returns output height value
OHPOS	-100/100	YES	Sets the value for output horizontal position
OHPOS?	NA	NA	Returns output horizontal position value
OVPOS	-100/100	YES	Sets the value for output vertical position
OVPOS?	NA	NA	Returns output vertical position value
OWIDTH	-100/100	YES	Sets the value for output width
OWIDTH?	NA	NA	Returns output horizontal width value

**Table 6-1. Serial Commands (continued)**

Command	Parameter (min/max)	Value Stored?	Description
<b>Miscellaneous Commands</b>			
BKGND	-100/100	YES	Sets the background color for letterbox or 4:3 aspect ratio (-100 = black; 100 = white)
BKGND?	NA	NA	Returns background setting value
DATE?	NA	NA	Returns product manufacture date
HDINPUTRES	NA	YES	Sets YPbPr input resolution and refresh rate for HD1/HD2, as follows: 0 = 480i 1 = 480p 2 = 576i 3 = 576p 4 = 720p / 60 Hz 5 = 1080i / 60 Hz 6 = 720p / 50 Hz 7 = 1080i / 25 Hz Any other value = Auto
HWVER?	NA	NA	Returns hardware version number
INRES?	NA	NA	Returns input resolution
LENS1	0 or 4	YES	Set primary lens configuration: 0 = No anamorphic lens present 4 = Anamorphic lens present
LENS1?	NA	NA	Returns Lens 1 configuration
LENS2	0 or 8	YES	Set anamorphic lens type: 0 = Fixed CineWide 8 = CineWide with AutoScope
LENS2?	NA	NA	Returns Lens 2 configuration
OUTRES	0/5	YES	Sets output resolution, as follows: 0 = 480i 1 = 576i 2 = 480p 3 = 576p 4 = 720p 5 = 1080i
OUTRES?	NA	NA	Returns output resolution
SWVER?	NA	NA	Returns software version number
TRIGGER	1/3	YES	Assigns trigger to currently-selected aspect ratio

**Notes:**

# 7. Specifications

Table 7-1 lists the VX-2ix specifications.

**Table 7-1. VX-2ix Specifications**

<b>Projector Type:</b>	Digital Light Processing (DLP), 3-chip, 16:9 DMD
<b>Native Resolution:</b>	1280 x 720 (16:9)
<b>Aspect Ratios:</b>	4:3, Letterbox, 16:9 Anamorphic, VirtualWide, Cinema, VirtualWide 2.35
<b>Video Standards:</b>	NTSC, PAL
<b>DTV Compatibility:</b>	480p, 720p, 1080i THX recommends the use of 720p source material for optimal performance with this product.
<b>Scan Frequency:</b>	Horizontal: 15 - 100 kHz Vertical: 28 - 78 Hz
<b>Picture Size (16:9 Screen):</b>	Recommended Width: 72 - 120 in. Maximum Width: 250 in.
<b>Throw Distance (Factor x Screen Width):</b>	Refer to Table 3-3
<b>Horizontal and Vertical Offset:</b>	Proteus A lens: None  All other lenses: Horizontal – 10% of screen width left or right of center Vertical (when ceiling-mounted) – 80% of screen height below center; 0% of screen height above center Vertical (when floor-mounted) – 0% of screen height below center; 80% of screen height above center

## 7.1 VX-2ix Specifications

**Table 7-1. VX-2ix Specifications (continued)****Brightness and Contrast:****Cinema Standards Measurement System (CSMS) Specifications**

- Brightness: 52.1 foot-Lamberts (fL)
- Contrast Ratio: 271:1

These measurements are taken from the projector in a controlled, home theater environment. All measurements are made to ANSI/NAPM IT7.228-1997 specifications using the Photo Research PR-650 SpectraColorimeter and Minolta LS-100 Luminance Meter, Video Essentials test DVD and a 1.3 gain, 72-inch wide screen. The projector is calibrated to a color temperature of 6,500K and has a minimum of 150 hours of usage.

The foot-Lambert (fL) is the unit of measurement used in commercial movie theaters to express image brightness at the screen surface. The Society of Motion Picture and Television Engineers (SMPTE) specifies 16 fL as the target image brightness for film-based projectors using an open gate (without film in the projector). More importantly, today SMPTE specifies 12 fL as the target image brightness in Digital Cinema theaters. The foot-Lambert measurement is dependent on screen size, screen gain and projector light output.

**Home Theater Calibration Specifications**

- Light Output: 1227 ANSI Lumens
- Contrast Ratio: 271:1

These specifications are obtained by calibrating the projector as described above for CSMS measurements.

**Industry-Standard Specifications**

- Light Output: 2500 ANSI Lumens
- Contrast Ratio: 3100:1

These are typical projector brightness and contrast specifications found in most companies' sales literature. Runco includes these measurements in its literature to allow for direct comparison with other manufacturers' projectors. These measurements are typically taken at 9,000K to 13,000K to get expected performance data when the projector is used in professional, commercial and industrial displays.

<b>Lamp:</b>	275 Watts
<b>Estimated Lamp Life:</b>	2000 hours
<b>Inputs:</b>	(1) Composite; (2) S-Video; (1) Component; (2) HD-R (Pr), G (Y), B (Pb), H, V; (2) DVI w/HDCP
<b>Control Options:</b>	<ul style="list-style-type: none"> <li>- Built-in keypad</li> <li>- Discrete infrared remote</li> <li>- Serial commands via RS-232</li> </ul>
<b>Trigger Outputs:</b>	(3) +12 VDC, each rated at 750 mA and thermal fuse-protected
<b>Bandwidth:</b>	150 Mega Samples/Second (MSPS)
<b>Power Requirements:</b>	100 to 240 VAC (auto-sensing), 50/60 Hz, 610 Watts
<b>Operating Environment:</b>	41°F to 95°F (5°C to 35°C), 0% to 90% humidity (non-condensing)
<b>Dimensions:</b>	See Figure 7-1
<b>Weight (without lens):</b>	84 lbs. (38.10 kg)
<b>Regulatory Approvals:</b>	Complies with FCC, CE C-Tick

---

**Table 7-1. VX-2ix Specifications (continued)**

<b>Limited Warranty:</b>	Projector: Two (2) years parts and labor from the date of delivery to the end user. Lamp: 1000 hours or six (6) months, whichever comes first.
--------------------------	---

**Specifications are subject to change without notice.**

## 7.2 VX-2ix Dimensions

Figure 7-1 shows the VX-2ix dimensions.

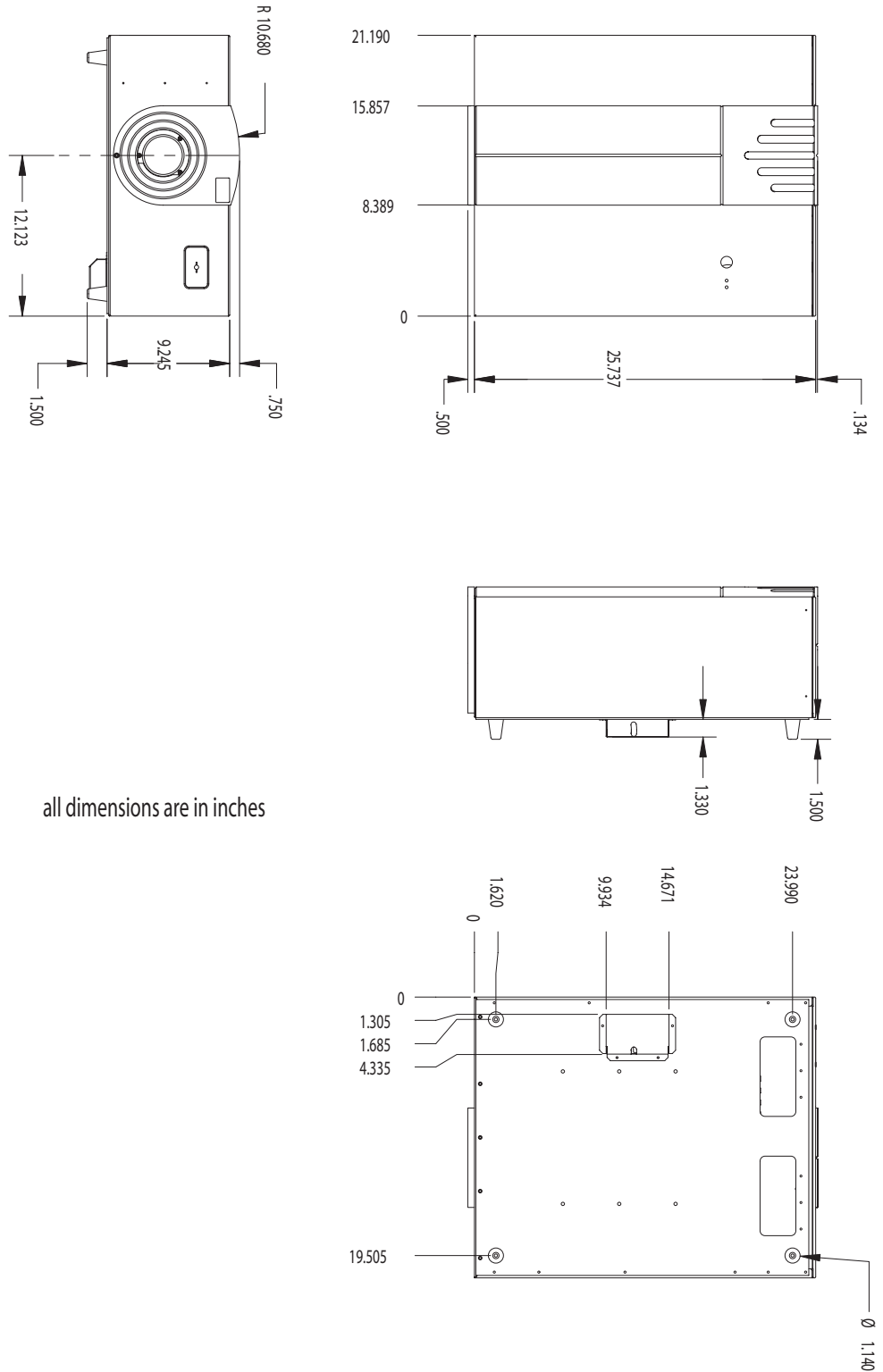

all dimensions are in inches

Figure 7-1. VX-2ix Dimensions



# Appendix A. VX-2ix Color Gamut Adjustment



Note

**Only ISF-trained and -certified technicians should attempt this procedure!**

For most applications, the Display Color controls in the Calibration menu are adequate for producing accurate and realistic colors from a variety of sources.

In rare cases, though, you may need more precise control over the VX-2ix display color gamut (range). For example, you may require a unique color gamut for a given projector or application. In such cases, you can access the VX-2ix's color gamut controls via serial commands. This enables you to define the precise hue of each primary color component (white, red, green and blue) used to generate the millions of colors produced in displays. You do this by specifying x and y coordinates for each primary color component.

The x and y coordinates for each color define its location on the standard CIE chromaticity graph, shown in Figure A-1. (CIE stands for "Commission Internationale de l'Éclairage" (International Commission on Illumination), the organization responsible for color measurement and management standards.)

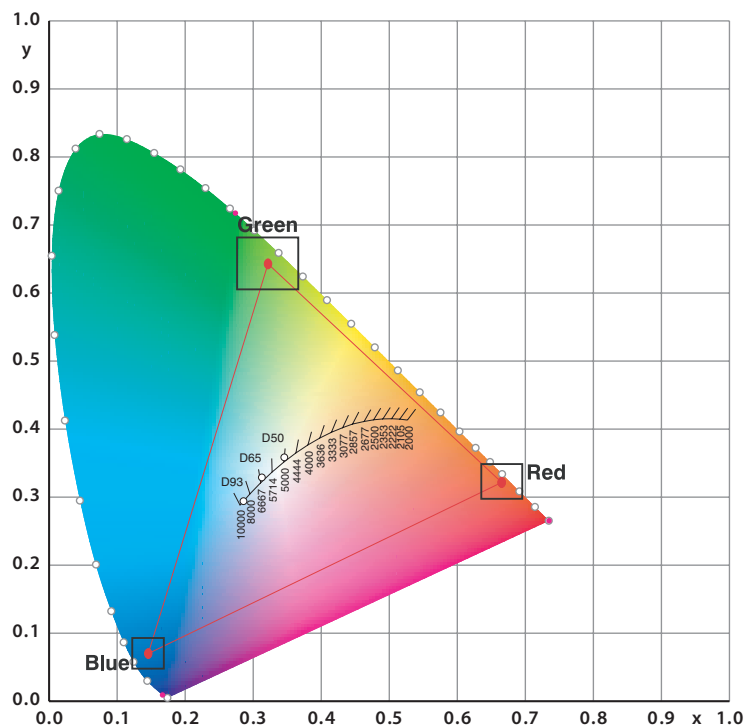

**Figure A-1. CIE 1931 Chromaticity Diagram**

Changing either or both of these numbers changes the hue of the color and relocates the "triangle" for possible colors. For example, changing the x/y coordinates for red moves the color closer to either orange or violet, which in turn affects all displayed colors having a red component.

## A.1 Required Hardware and Software

To perform these adjustments, you need the following:

- Laptop or desktop PC with a DB-9 serial port.
- A straight-through (not null-modem) serial cable (DB-9 female to DB-9 male).
- A DB-9 female-to-3.5mm phono plug adapter.
- Terminal emulation software – HyperTerminal or equivalent.
- Color analyzer – Sencore ColorPro 5000 software and ColorPro III sensor, or equivalent.



### Note

Most computer-based color analyzers – like the Sencore product used here as an example – also require a serial connection for the color sensor. In order to use them for this procedure, your PC must have either two available RS-232 COM ports, or one COM port and one Universal Serial Bus (USB) port.

If you are using a stand-alone color analyzer, this is not an issue.

## A.2 Serial Connections and Equipment Setup

Connect your PC to the projector and color sensor as shown in Figure A-2.

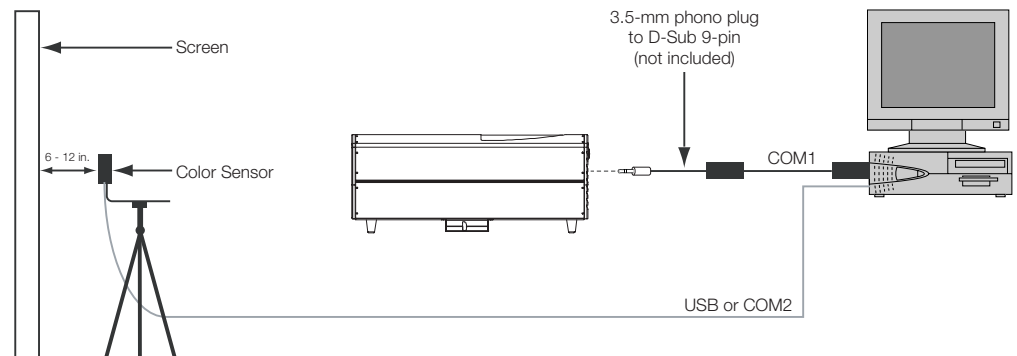

**Figure A-2. Equipment Setup for Color Gamut Adjustment**

1. Connect a straight-through serial cable to the computer's serial port.
2. Connect the other end of the serial cable to a 9-pin-to-3.5mm phono plug adapter.
3. Connect the 3.5-mm phono plug to the secondary RS-232 port on the rear of the projector. This port is not labeled, but is to the right of and slightly below the primary RS-232 port; see Figure A-3.

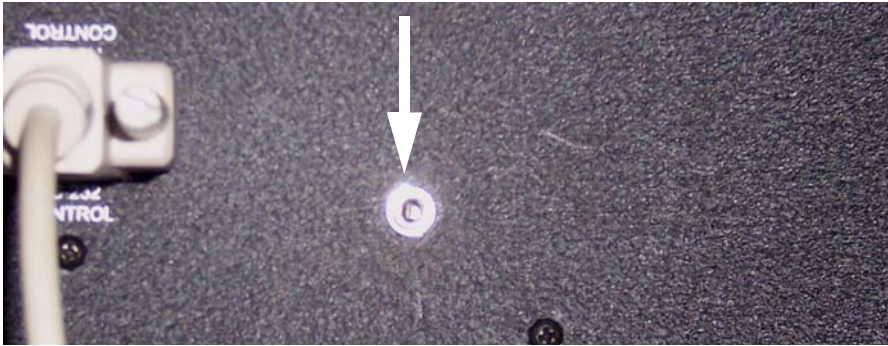

**Figure A-3. VX-2ix Secondary RS-232 Port**

4. Connect the color sensor to any available COM or USB port.
5. Launch HyperTerminal. Open a connection using these parameters: 19200 baud, 8 data bits, no parity, 1 stop bit and no flow control.
6. Press **<Enter>**. The VX-2ix responds with “+>” to indicate that it is ready to accept commands.
7. Start your color analyzer. Position the sensor approximately 6 to 12 inches from the screen, facing it at a slight angle (upward or to one side) so that the color of the screen is included in the calibration.

Table A-1 lists the serial command set for color gamut adjustments. The “Parameter (min/max)” column shows the valid parameter ranges, or “NA” for commands that take no parameters.

When you enter a valid command, the VX-2ix executes it and acknowledges it with a plus sign on the command line (+ >). When you enter an invalid command – one that is misspelled or followed by values outside the valid range for that command – the VX-2ix ignores it and returns a minus sign (- >).

**Table A-1. Serial Commands for Gamut Adjustment**

Command	Parameter (min/max)	Value Stored?	Description
GAMUT WHITE	NA	NA	Displays white field on screen for measuring x and y coordinates; shows current x and y coordinates for white on the command line.
GAMUT RED	NA	NA	Displays red field on screen for measuring x and y coordinates; shows current x and y coordinates for red on the command line.

### **A.3 Serial Command Syntax**

**Table A-1. Serial Commands for Gamut Adjustment (continued)**

Command	Parameter (min/max)	Value Stored?	Description
GAMUT GREEN	NA	NA	Displays green field on screen for measuring x and y coordinates; shows current x and y coordinates for green on the command line.
GAMUT BLUE	NA	NA	Displays blue field on screen for measuring x and y coordinates; shows current x and y coordinates for blue on the command line.
GAMUT SET WHITE [x] [y]	x = 0.0 / 0.8 y = 0.0 / 0.9	YES	Sets x and y coordinates for white.
GAMUT SET RED [x] [y]	x = 0.0 / 0.8 y = 0.0 / 0.9	YES	Sets x and y coordinates for red.
GAMUT SET GREEN [x] [y]	x = 0.0 / 0.8 y = 0.0 / 0.9	YES	Sets x and y coordinates for green.
GAMUT SET BLUE [x] [y]	x = 0.0 / 0.8 y = 0.0 / 0.9	YES	Sets x and y coordinates for blue.
GAMUT OFF	NA	NA	Applies new gamut setting (if changed) and goes back to normal picture.

## A.4 Adjusting the Gamut

1. In HyperTerminal, type `gamut white` and press **<Enter>**. The VX-2ix displays a white field on the screen and the current x and y coordinates for white on the command line.
2. Using the color analyzer, measure the x and y coordinates for about 15 seconds. Make a note of the results.
3. In HyperTerminal, use the `gamut set white` command to change the x and y coordinates to the values you obtained in Step 2. For example, if the readings were x=0.284 and y=0.294, type `gamut set white 0.284 0.294` and press **<Enter>**.
4. To confirm the change, repeat Step 1. The displayed x and y values should match what you just entered.
5. Type `gamut red` and press **<Enter>**. The VX-2ix displays a red field on the screen and the current x and y coordinates for red on the command line.
6. Repeat Step 2.
7. In HyperTerminal, use the `gamut set red` command to change the x and y coordinates to the values you obtained in Step 6.
8. To confirm the change, repeat Step 5. The displayed x and y values should match what you just entered.

- 
9. Type `gamut green` and press **<Enter>**. The VX-2ix displays a green field on the screen and the current x and y coordinates for green on the command line.
  10. Repeat Step 2.
  11. In HyperTerminal, use the `gamut set green` command to change the x and y coordinates to the values you obtained in Step 10.
  12. To confirm the change, repeat Step 9. The displayed x and y values should match what you just entered.
  13. Type `gamut blue` and press **<Enter>**. The VX-2ix displays a blue field on the screen and the current x and y coordinates for blue on the command line.
  14. Repeat Step 2.
  15. In HyperTerminal, use the `gamut set blue` command to change the x and y coordinates to the values you obtained in Step 14.
  16. To confirm the change, repeat Step 13. The displayed x and y values should match what you just entered.
  17. Type `gamut off` and press **<Enter>**. The VX-2ix stores the new x and y coordinates and returns to normal operation.

When you have completed the gamut adjustments, proceed with the Display Color adjustments; refer to **Calibration** on page 38.

**Notes:**





SERIAL NUMBER  
RUMA-011155  
rev 09-27-06 v2.2